

F-SERIES (BDC & FEM) TEST PLATFORM

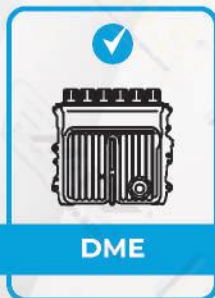

EGS



DME

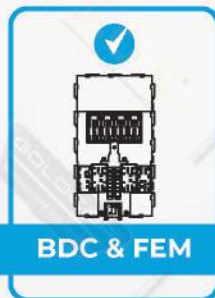

BDC & FEM



DASHBOARD



ANTENNA RECEIVER



PRODUCT MANUAL

VERSION 2.0

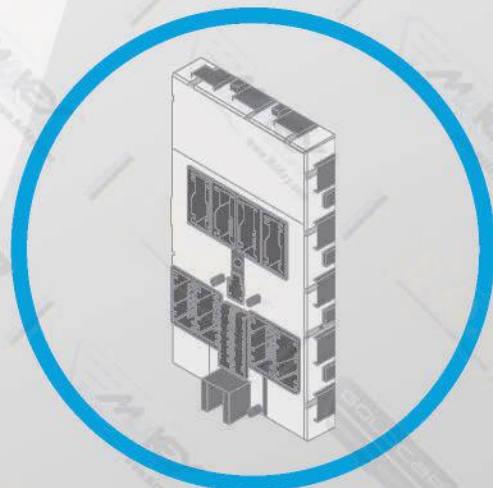

Full Functional Description

The F-SERIES BDC & FEM Test Platform supports BMW F-Series BDC and FEM immobilizer modules, instrument cluster, antenna receiver, and other ECUs. EGS and DME modules are supported without the need for connectors.

Using the **dashboard control button** located on the device, you can power up and operate the instrument cluster directly without connecting a BDC or FEM module. Additionally, the +12V supply can be switched ON/OFF via the 15 WUP output cable.

Thanks to the integrated steering lock data stored inside the unit, the BDC & FEM module can be operated on bench without requiring a physical steering lock.

With the built-in Universal Diagnosis socket, the device can be used universally with tools such as Autel, AVDI, CGDI, VVDI, and similar diagnostic equipment.

For Extra Autohex-II On-Bench compatibility, the Autohex-II DB25 cable can be directly connected to the BDC & FEM Testing Tool OBD DB25 port.

The BDC & FEM Test Device is equipped with a dedicated Autohex-II EEPROM output, allowing direct connection of your Autohex-II EEPROM adapter.

Features

- **Support:** BDC and FEM IMMO systems.
- **Support:** Dashboard forced wake-up by CAN signal.
- **Support:** Connect more control units by hand.
- **Support:** Steering Lock Data
- **Support:** Universal Diagnosis compatible with devices
- **Support:** Diagnosis or coding programming on the bench.
- **Support:** Autohex-II Eeprom output
- **Support:** Remote control LED output via by CAN signal
- **Support:** LED output controlled by indicator clock by CAN signal

Tester Details

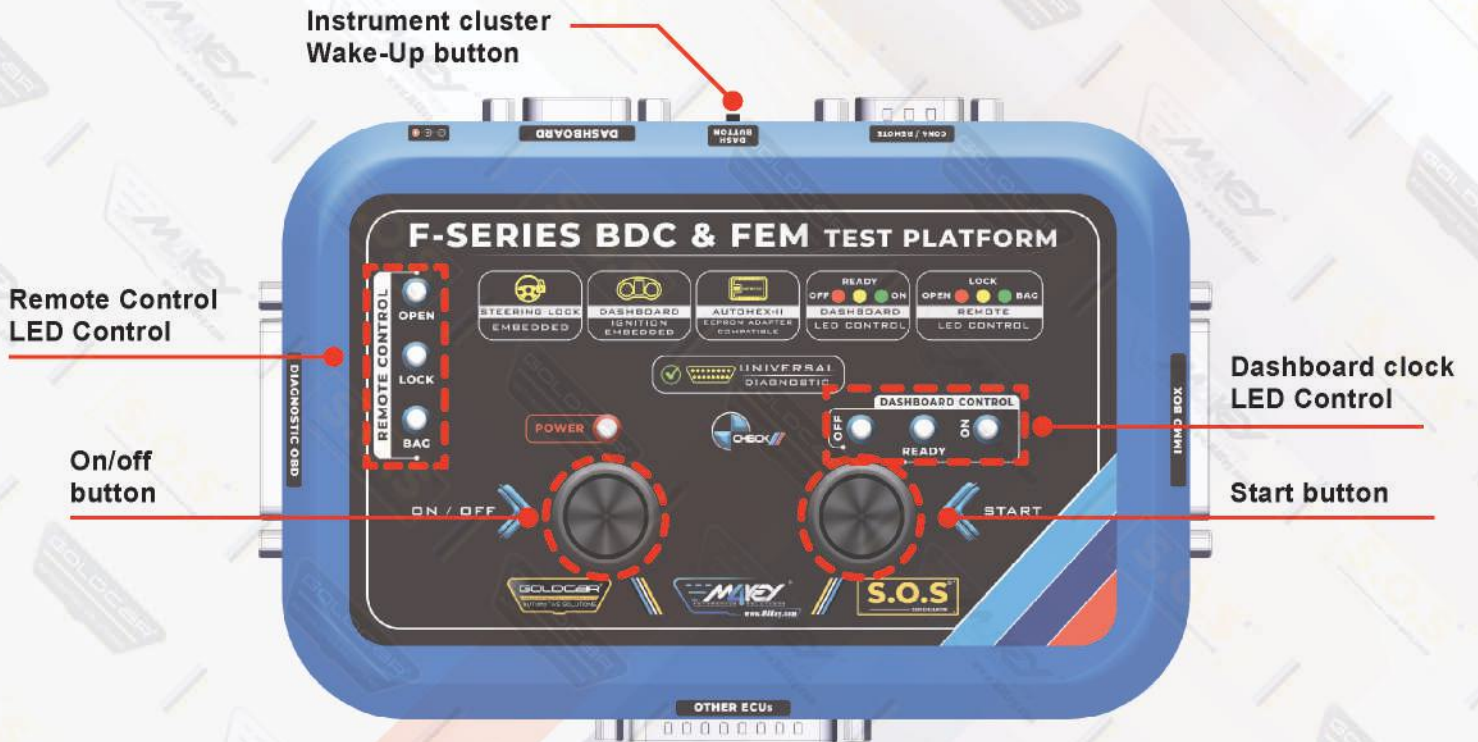

LED Introduction

POWER

When the red LED is lit, the device voltage is operational.

OPEN

Remote control power button

LOCK

Remote control lock button

BAG

Remote trunk button

ON

The instrument cluster is awake, and the vehicle has been started.

READY

Instrument cluster – ignition ON (standby mode)

OFF

Dashboard clock is off

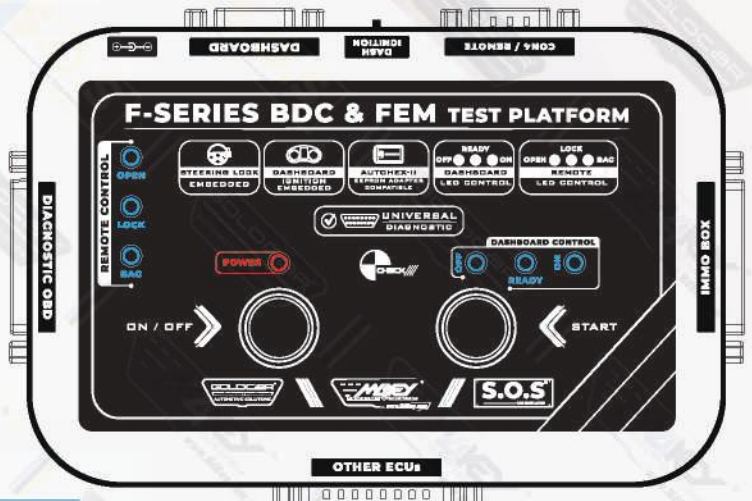

DB Connector Details

The test platform has **5 positions** to insert DB cable. Which is convenient for users to connect any control unit together and complete programming, diagnosis and other work on the bench.



Pack List



Other ECUs Pin Terminals



Instructions for use

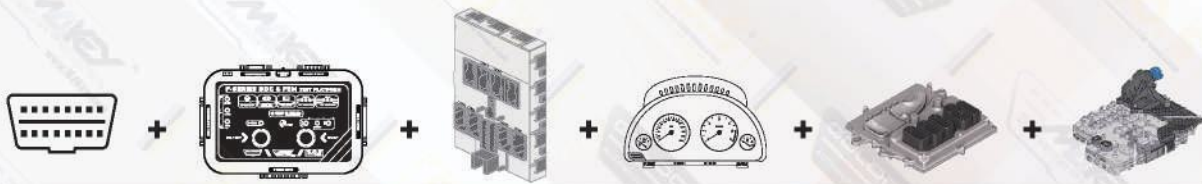

FULL DIAGNOSTIC TEST

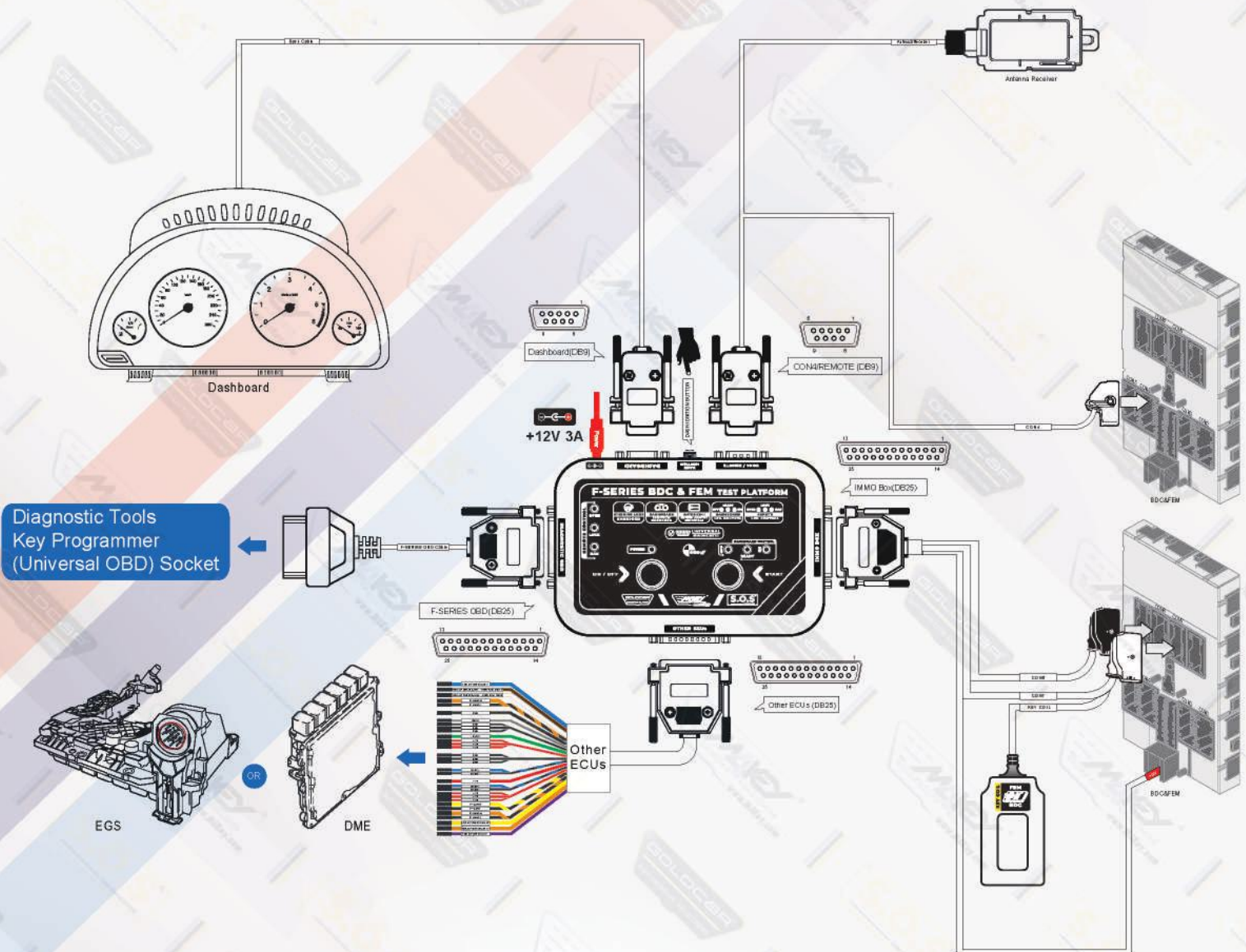

Universal Obd Instructions for use



FULL DIAGNOSTIC TEST

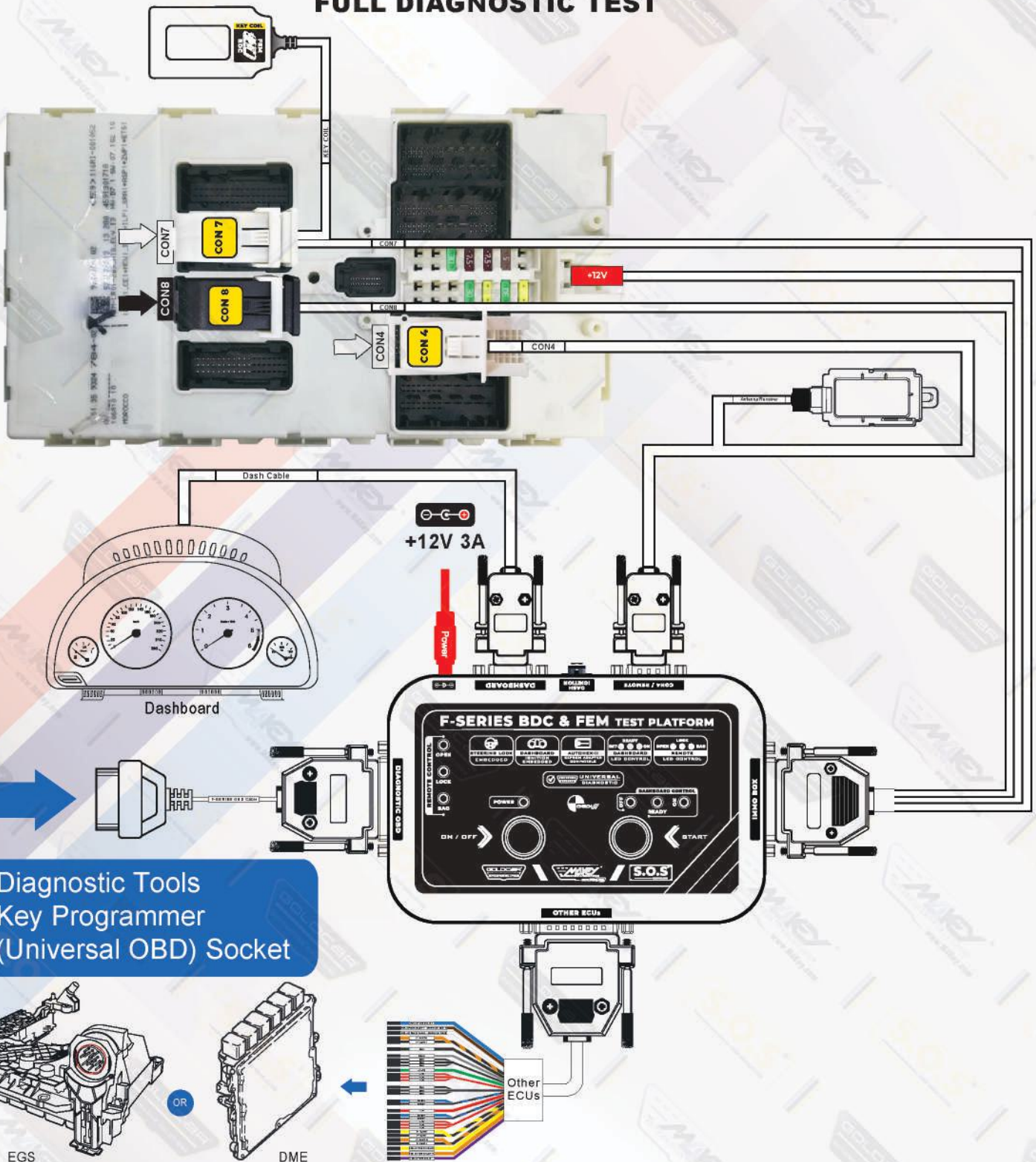

Diagnostic Tools
Key Programmer
(Universal OBD) Socket

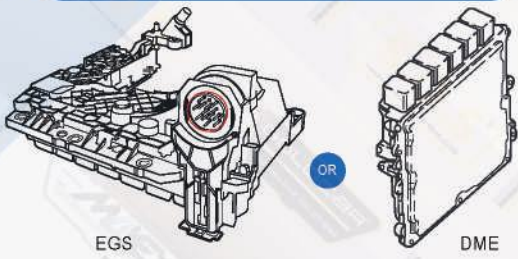

Universal Obd Instructions for use



UNIVERSAL FEM TEST

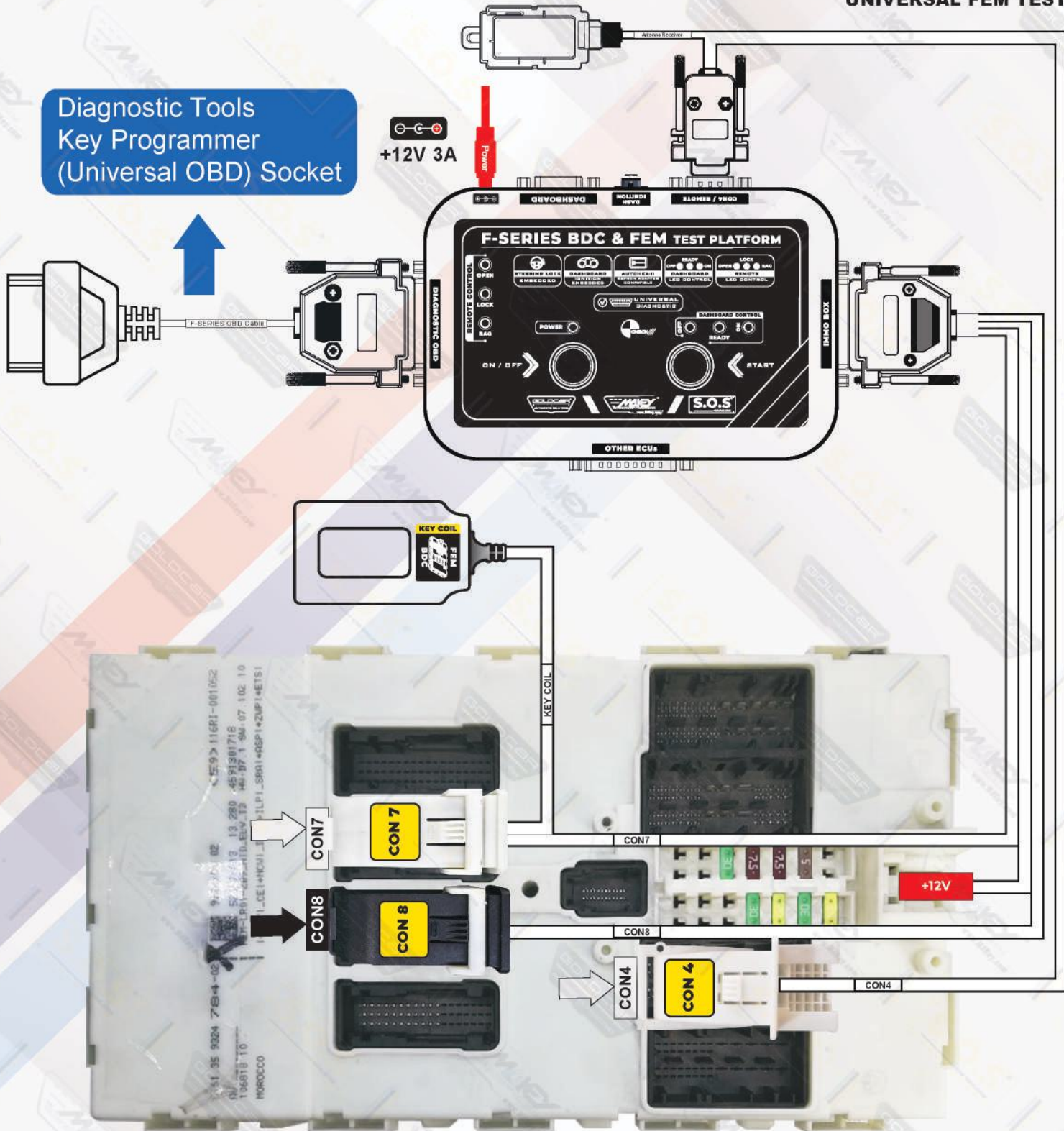

Diagnostic Tools
Key Programmer
(Universal OBD) Socket

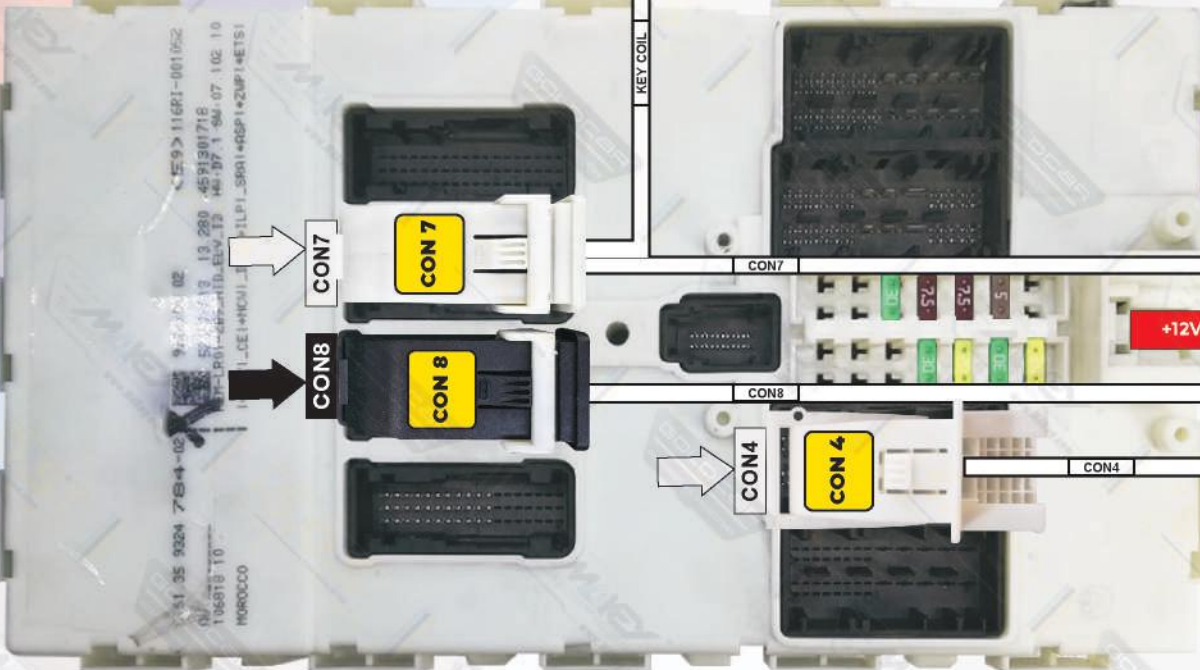

Autohex-II Eeprom Adapter Instructions for use



+12V 3A
Power

Please use +12V here.

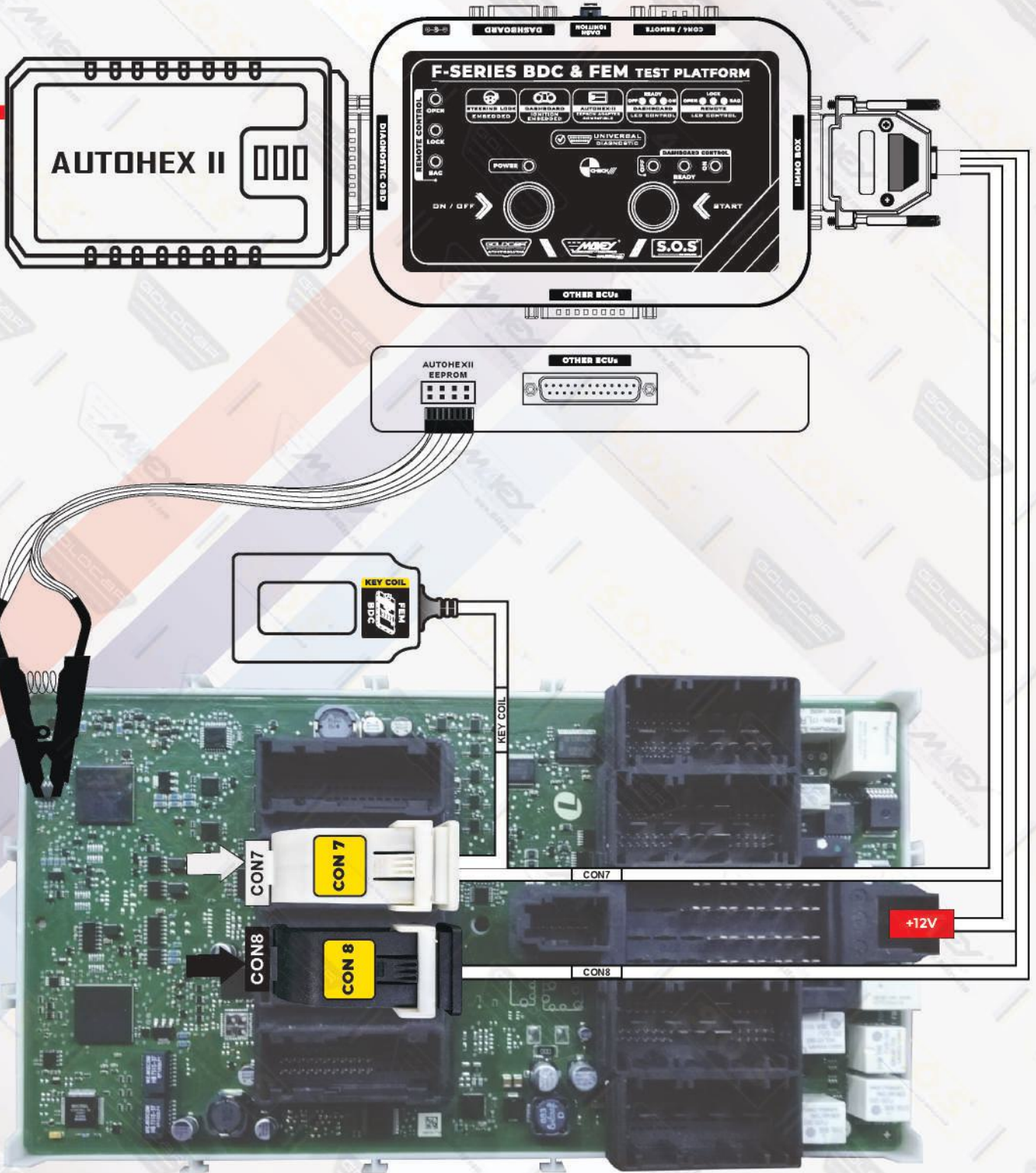

Dash Ignition Button

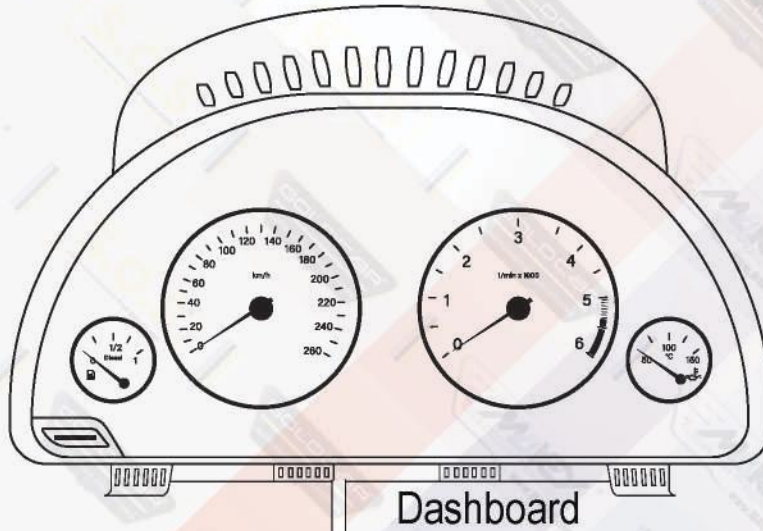

Dashboard

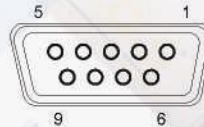
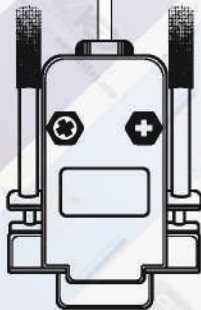

Dashboard(DB9)

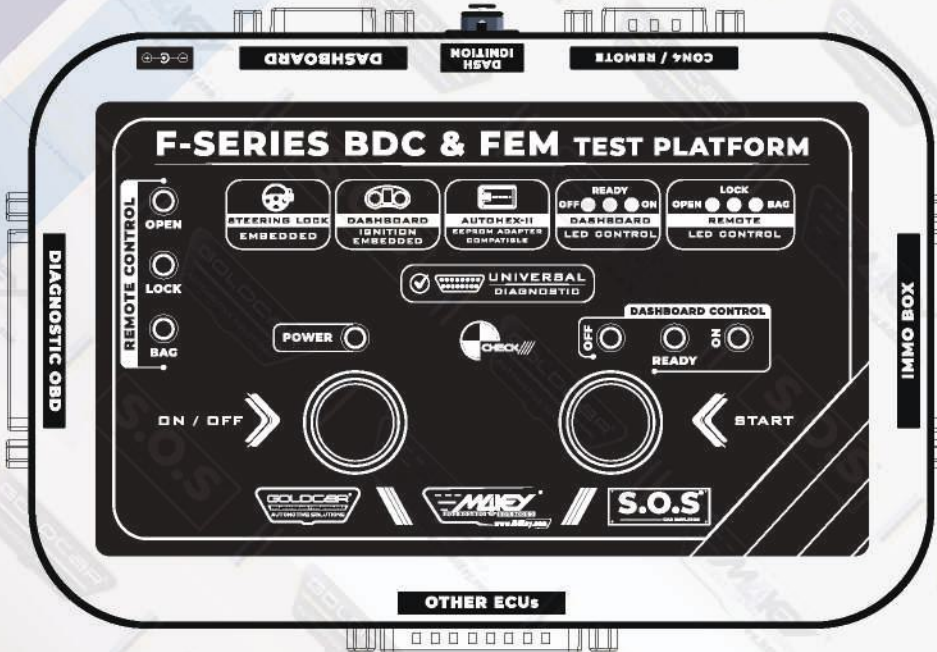

Other ECUs



DME & +8H EGS

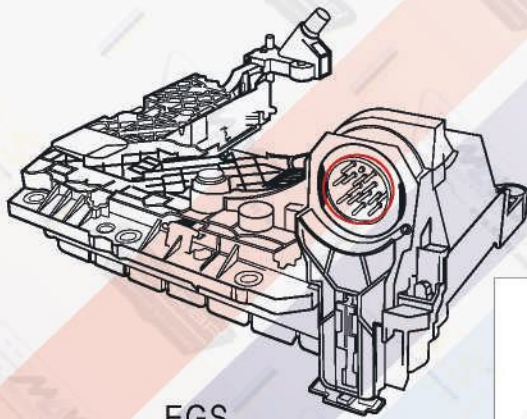
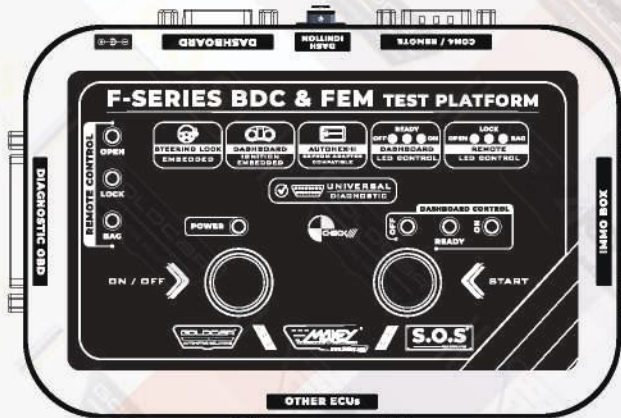

EGS

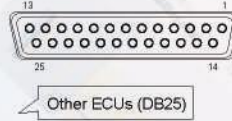
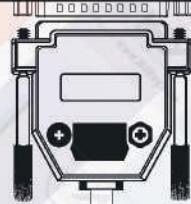

Other ECUs (DB25)

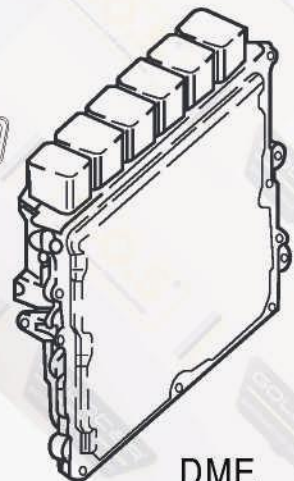

DME

Other ECUs

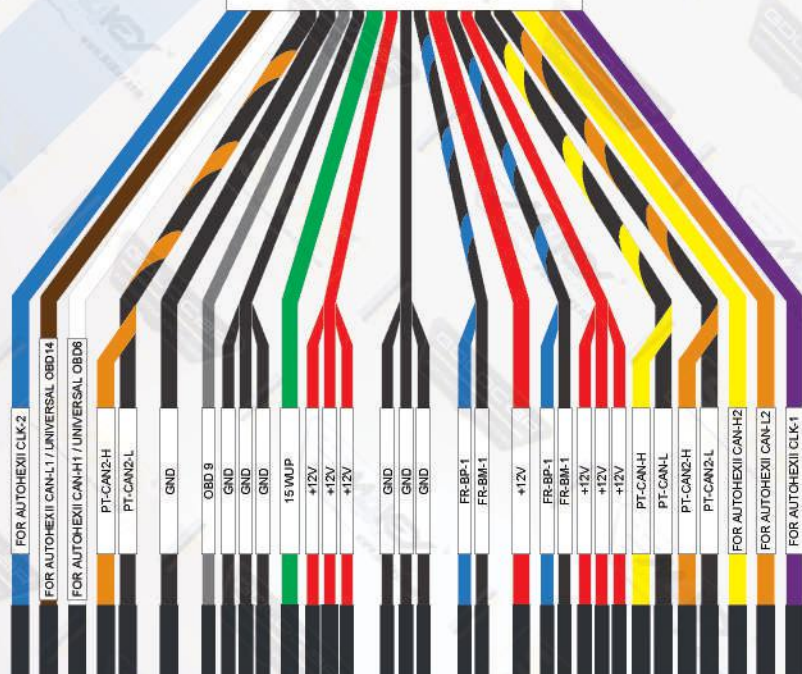

Other ECUs Pin Out

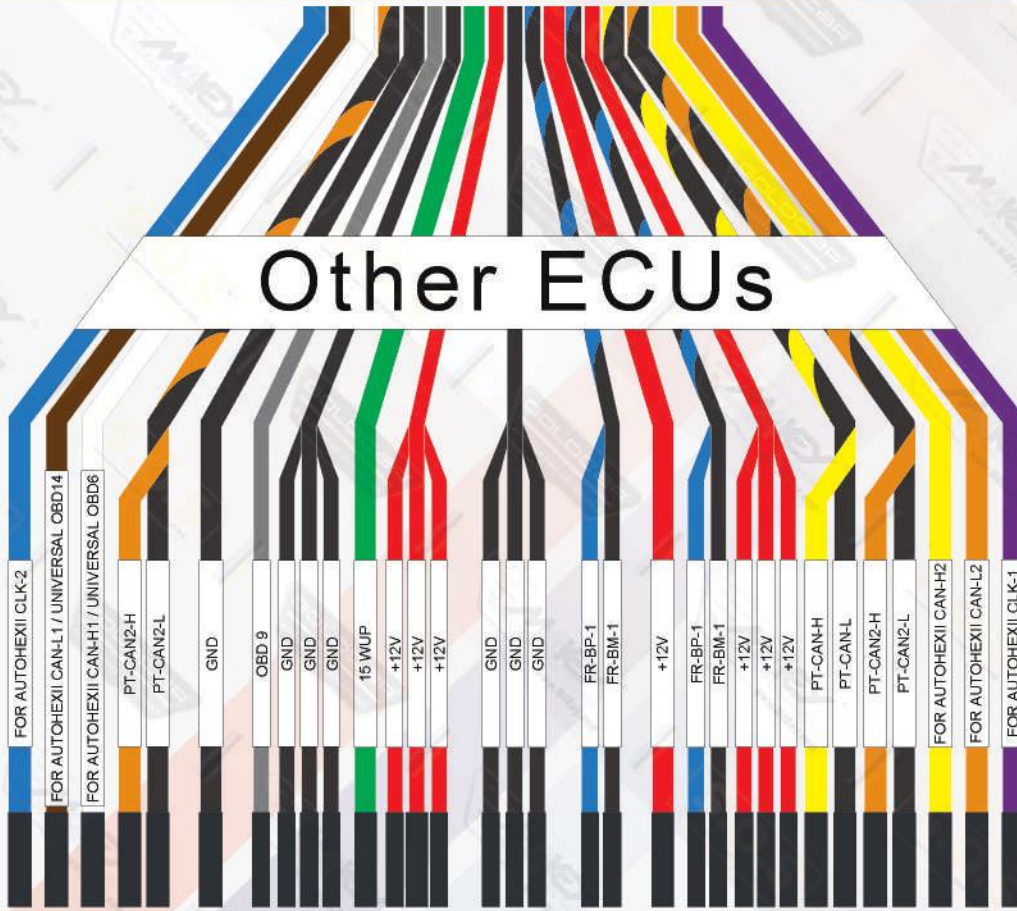

BLUE	CLK-2
BROWN	FOR AUTOHEXII CAN-L1 UNIVERSAL OBD14
WHITE	FOR AUTOHEXII CAN-H1 UNIVERSAL OBD6
ORANGE	PT-CAN2-H
BLACK	PT-CAN2-L
BLACK	GND
GREY	OBD 9
BLACK	GND
BLACK	GND
BLACK	GND
BLACK	GND
GREEN	15 WUP
RED	+12V
RED	+12V
RED	+12V
BLACK	GND
BLACK	GND

BLACK	GND
BLUE	FR-BP-1
BLACK	FR-BM-1
RED	+12V
BLUE	FR-BP-1
BLACK	FR-BM-1
RED	+12V
RED	+12V
RED	+12V
YELLOW	PT-CAN-H
BLACK	PT-CAN-L
ORANGE	PT-CAN2-H
BLACK	PT-CAN2-L
YELLOW	FOR AUTOHEXII CAN-H2
ORANGE	FOR AUTOHEXII CAN-L2
PURPLE	CLK-1

On Bench Full Diagnostic Test

MEVD1724

MEVD1724, MEVD1725, MEVD1728,
MEVD1729, MEVD172H, MEVD172P
+8H EGS

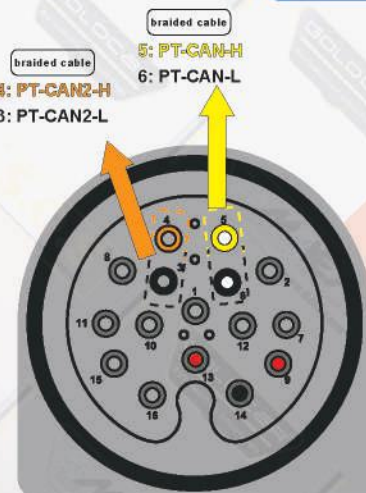
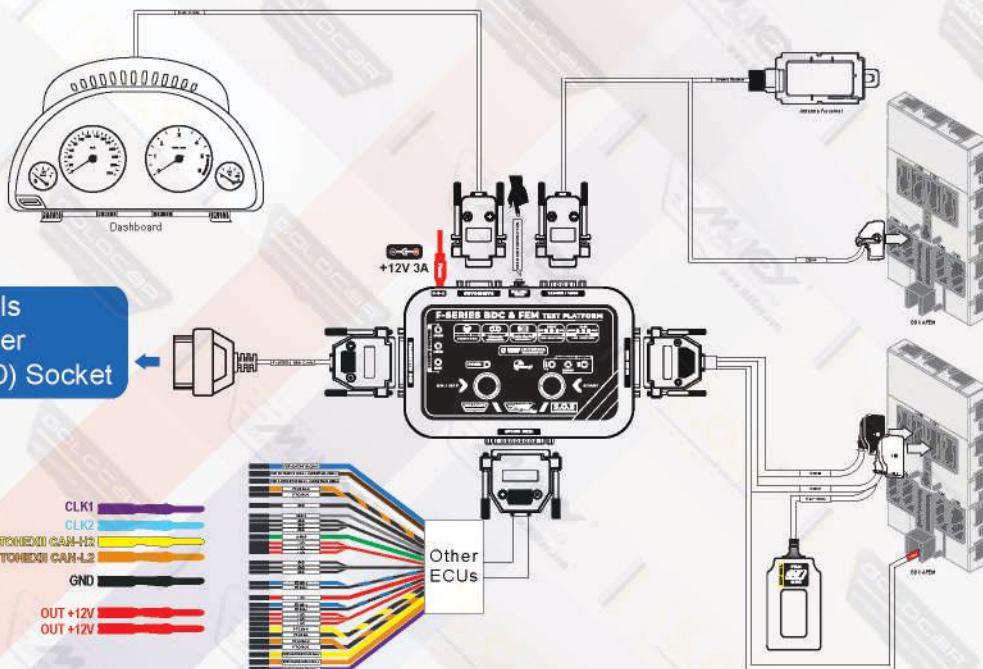
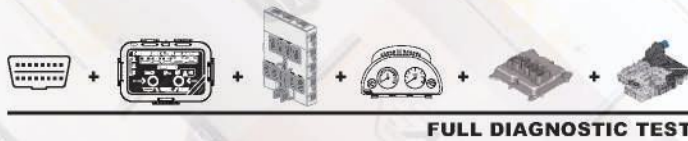

- CLK1
- CLK2
- AUTOTRONIC CAN-H2
- AUTOTRONIC CAN-L2
- GND
- OUT +12V
- OUT +12V

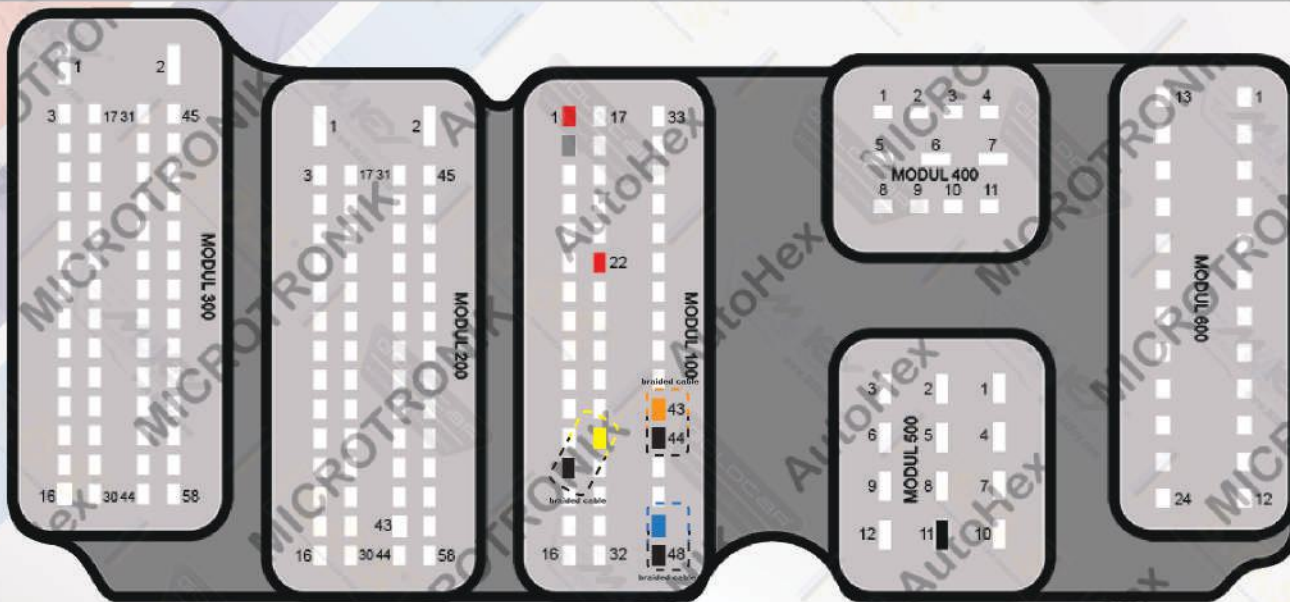

- MODUL 100, 1: Out +12V
MODUL 100, 22: Out +12V
- MODUL 500, 11: GND
- MODUL 100, 28: PT-CAN-H
MODUL 100, 13: PT-CAN-L
braided cable
- MODUL 100, 47: FR-BP-1
MODUL 100, 48: FR-BM-1
braided cable
- MODUL 100, 43: PT-CAN2-H
MODUL 100, 44: PT-CAN2-L
braided cable
- MODUL 100, 02: OBDS9

On Bench Full Diagnostic Test

On Bench MSD90 ISN +8H EGS

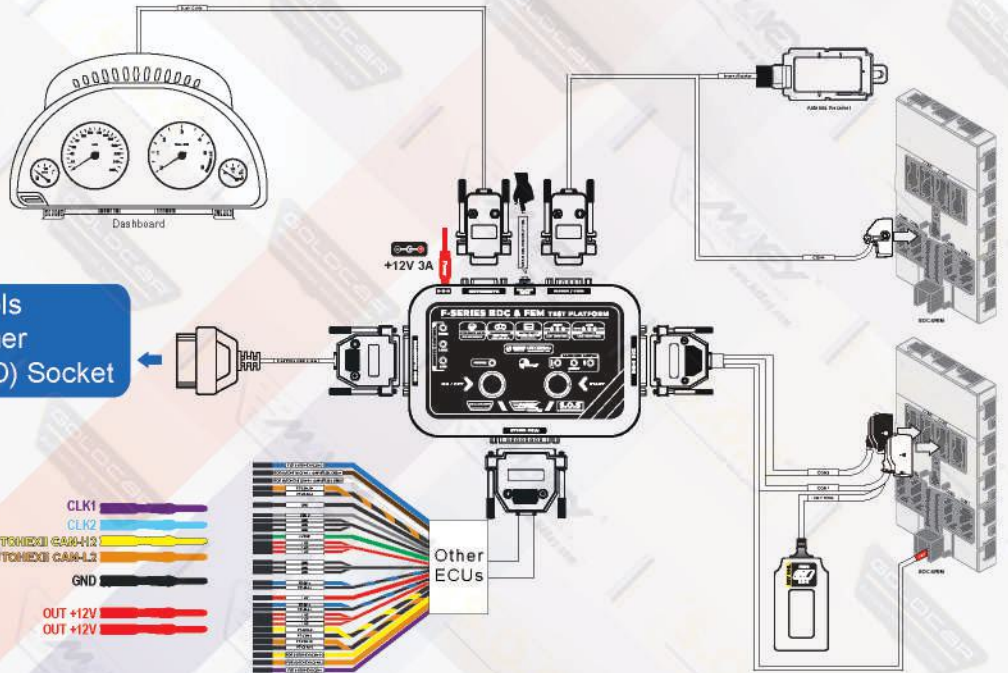
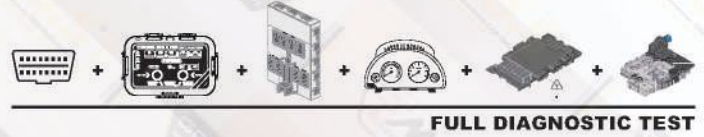

Diagnostic Tools
Key Programmer
(Universal OBD) Socket

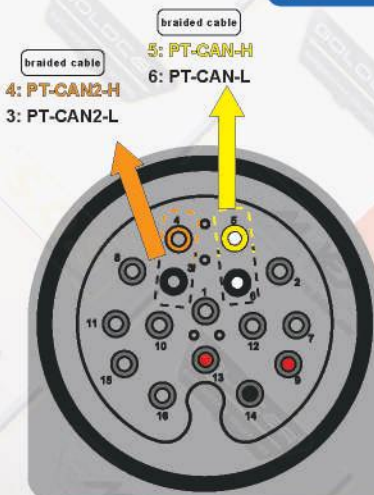

- CLK1
- CLK2
- AUTONEXI CAN-H12
- AUTONEXI CAN-L3
- GND
- OUT +12V
- OUT +12V

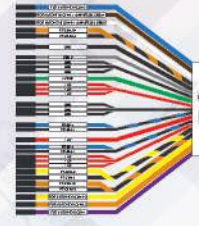

9: +12V 13: +12V	14: GND	5: PT-CAN-H 6: PT-CAN-L braided cable	4: PT-CAN2-H 3: PT-CAN2-L braided cable
---------------------	---------	---	---

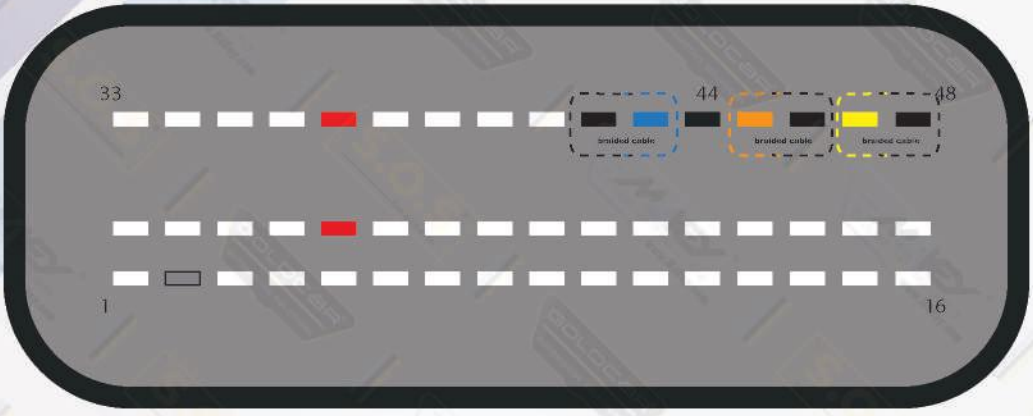

37: Out +12V 21: Out +12V	44: GND	47: PT-CAN-H 48: PT-CAN-L braided cable	43: FR-BP-1 42: FR-BM-1 braided cable	45: PT-CAN2-H 46: PT-CAN2-L braided cable	02: OBD9
------------------------------	---------	---	---	---	----------

On Bench Full Diagnostic Test

MEVD1723 +8H EGS

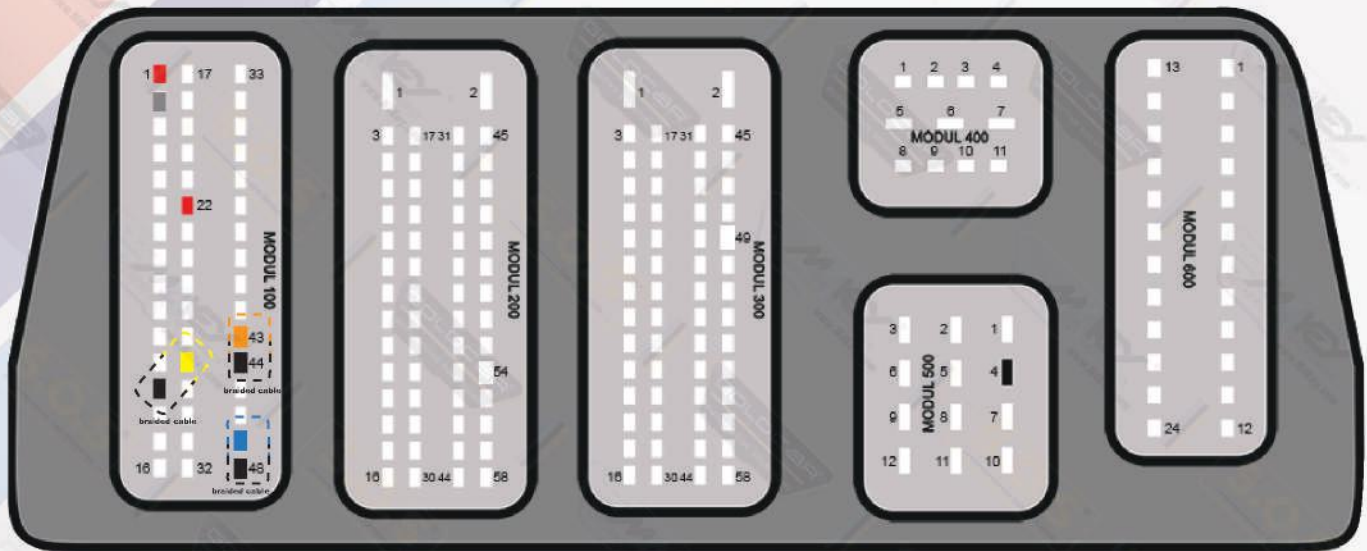
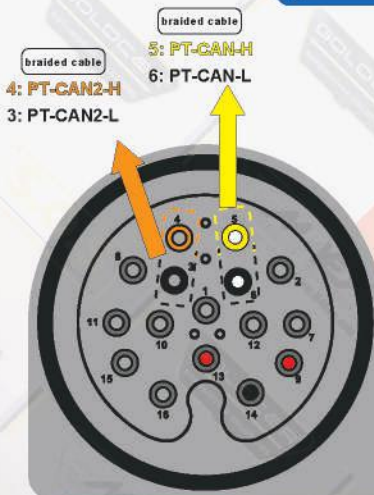
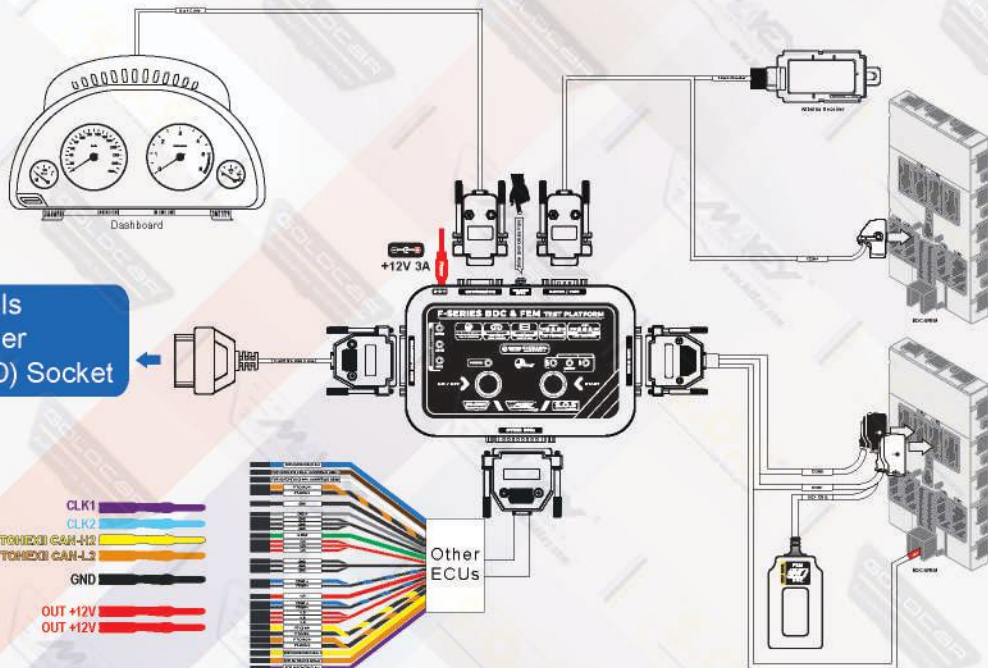
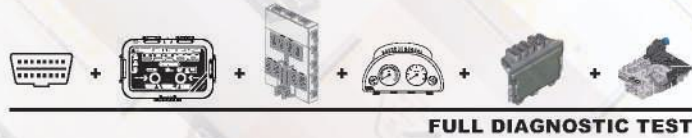

On Bench Full Diagnostic Test

EDC17Cp49

EDC17Cp49, EDC17C50, EDC17C56,
EDC17C76 +8H EGS

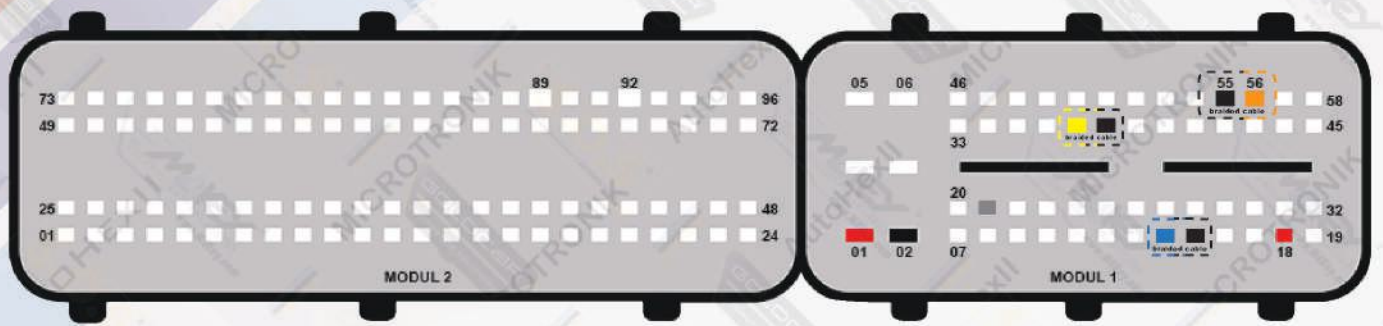
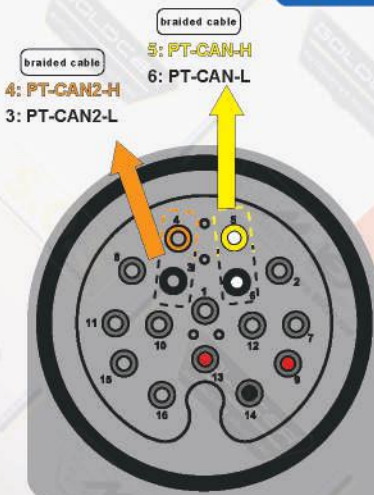
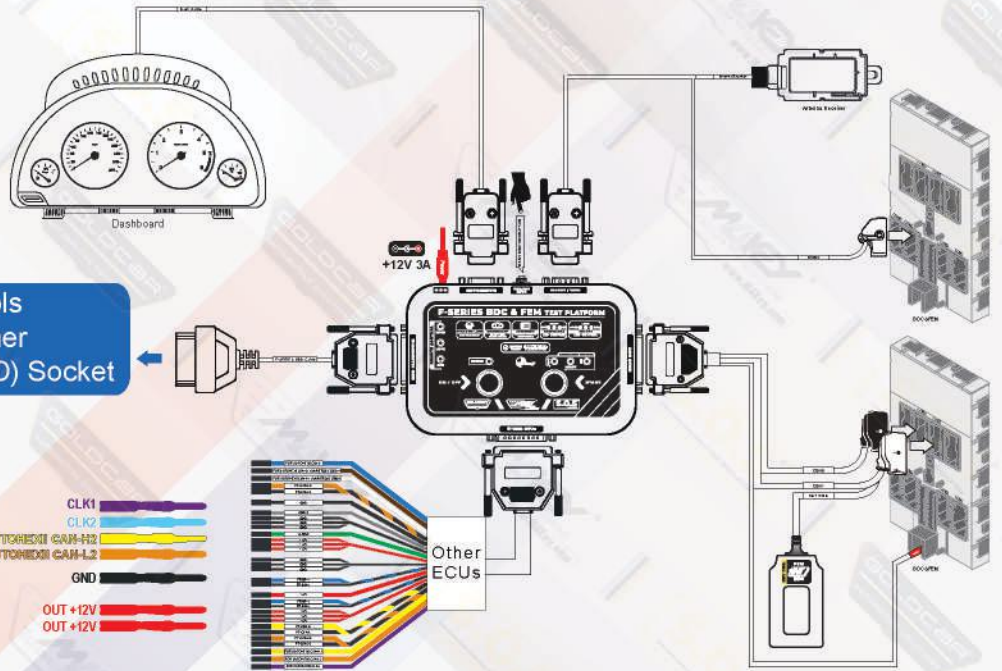
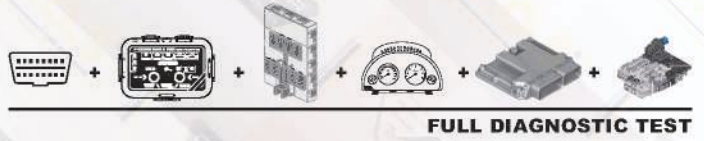

On Bench Full Diagnostic Test

MEVD172

MEVD172, MEVD1726, MEVD172G
+8H EGS

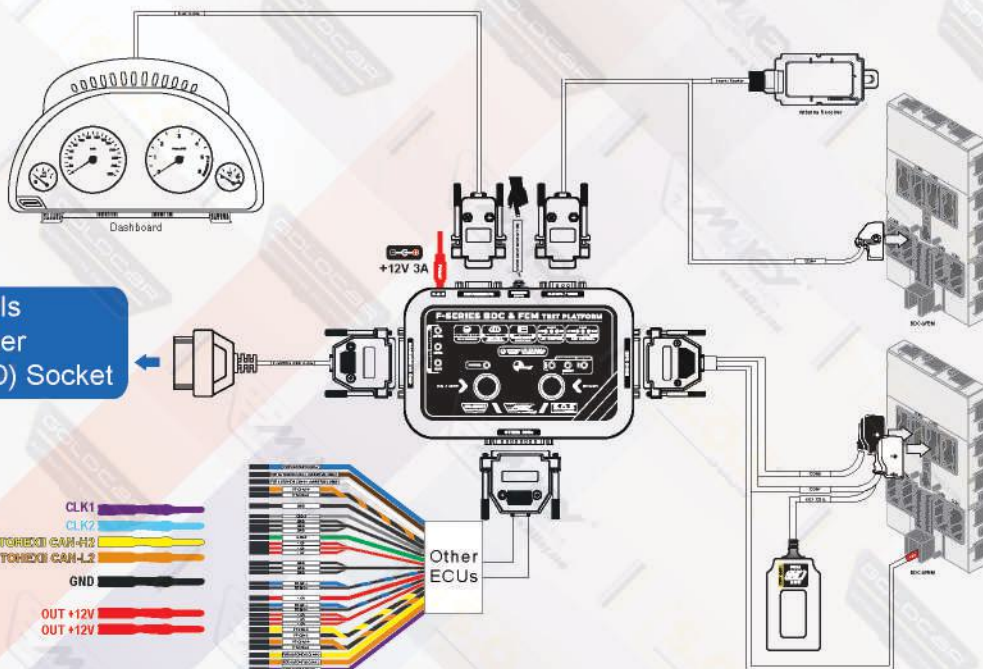
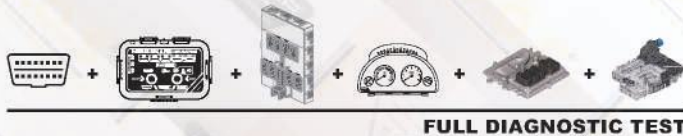

Diagnostic Tools
Key Programmer
(Universal OBD) Socket

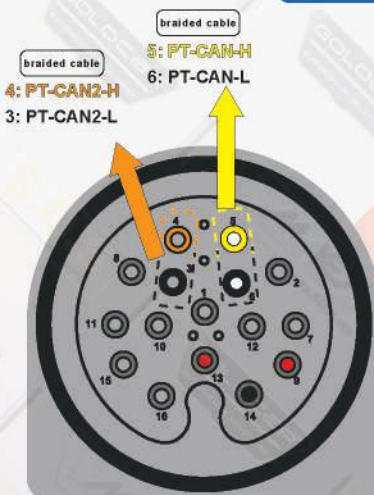

- CLK1
- CLK2
- AUTORECI CAN-H2
- AUTORECI CAN-L2
- GND
- OUT +12V
- OUT +12V

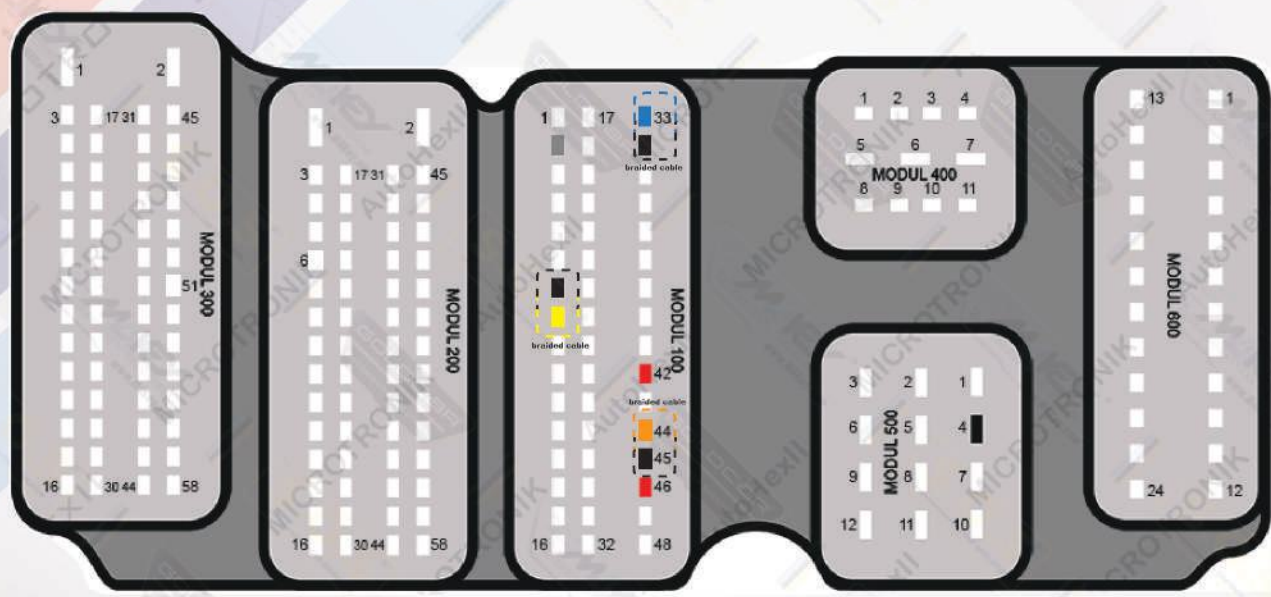

- MODUL 100, 42: Out +12V
 - MODUL 100, 46: Out +12V
 - MODUL 500, 04: GND
 - MODUL 100, 8: PT-CAN-H
 - MODUL 100, 7: PT-CAN-L
 - MODUL 100, 33: FR-BP-1
 - MODUL 100, 34: FR-BM-1
 - MODUL 100, 44: PT-CAN2-H
 - MODUL 100, 45: PT-CAN2-L
 - MODUL 100, 02: OBD9
- braided cable braided cable braided cable

Autohex-II On Bench Manual

EDC17C41 / EDC17CP09 / EDC17CP45

EDC17C41, EDC17Cp45

- Autohex-II Software ON-Bench (Please connect to the +12V AUTOHEX-II Box)
- Unplug DME from the car
- Connect wires to DME based on the below connection diagram using
- Select the DME Type from AutoHex software
- Read ISN from DME



AUTOHEXII ON BENCH ISN READ

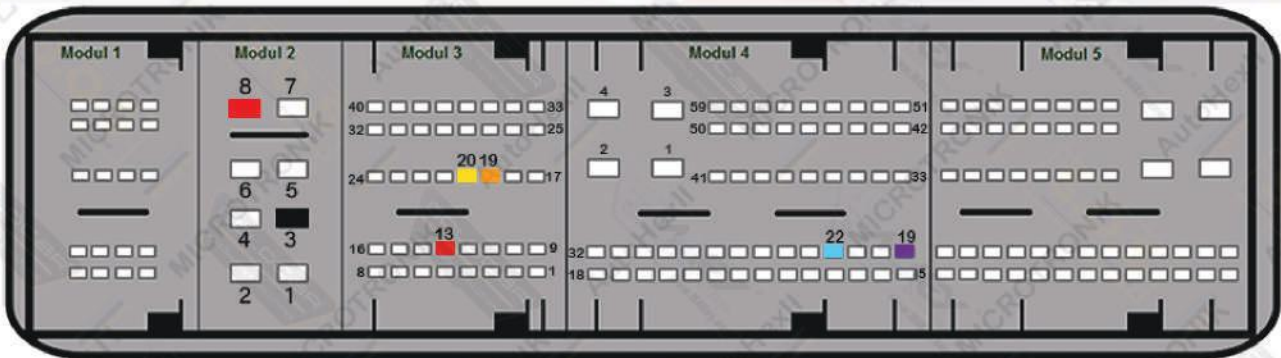

MODUL 2, 08: Out +12V
MODUL 3, 13: Out +12V

MODUL 2, 03: GND

MODUL 3, 20: AUTOHEXII CAN-H2
MODUL 3, 19: AUTOHEXII CAN-L2

MODUL 4, 19: CLK1
MODUL 4, 22: CLK2

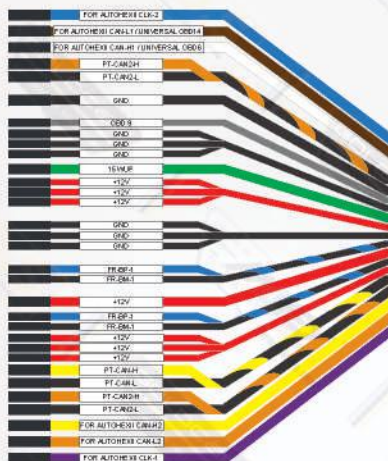
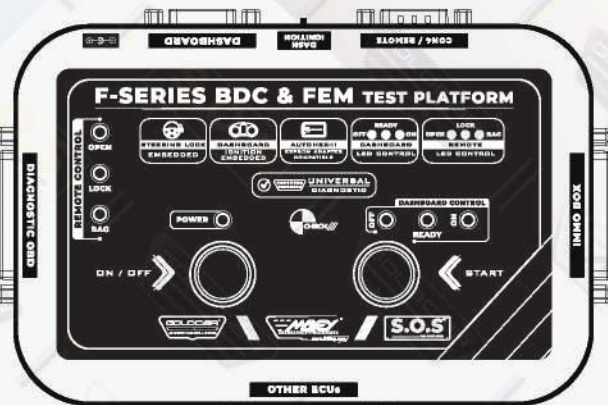

Other ECUs

Autohex-II On Bench Manual

MEVD172

MEVD172, MEVD1726, MEVD172G



- Autohex-II Software ON-Bench (Please connect to the +12V AUTOHEX-II Box)
- Unplug DME from the car
- Connect wires to DME based on the below connection diagram using
- Select the DME Type from AutoHex software
- Read ISN from DME

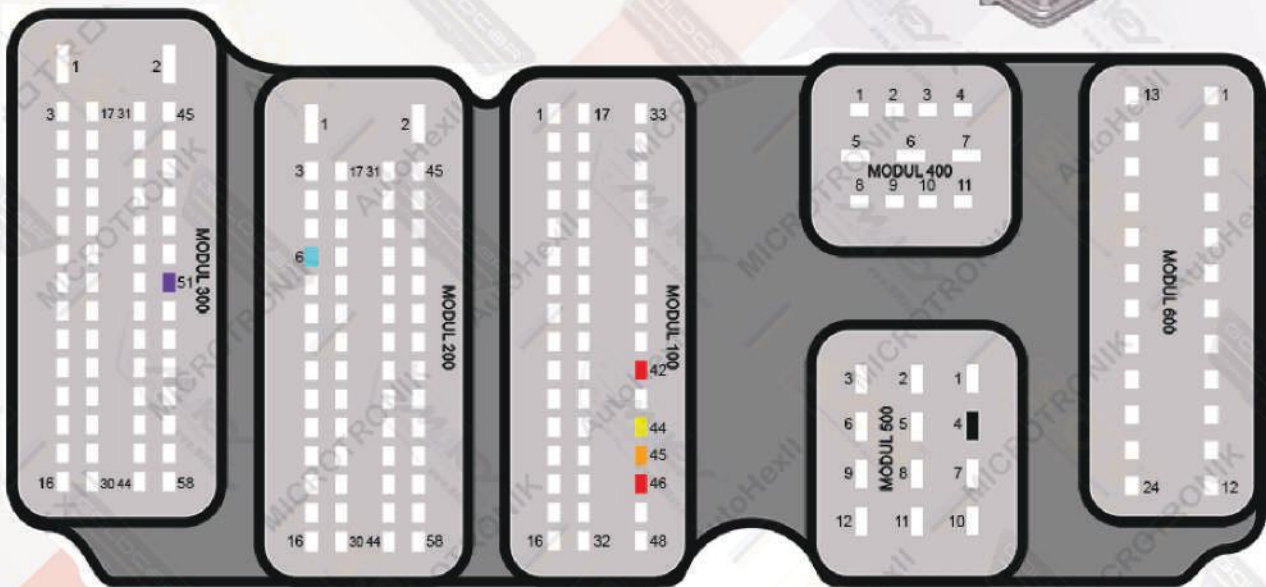

MODUL 100, 42: Out +12V
MODUL 100, 46: Out +12V

MODUL 500, 04: GND

MODUL 100, 44: AUTOHEXII CAN-H2
MODUL 100, 45: AUTOHEXII CAN-L2

MODUL 300, 51: CLK1
MODUL 200, 6: CLK2



+12V 3A
Power

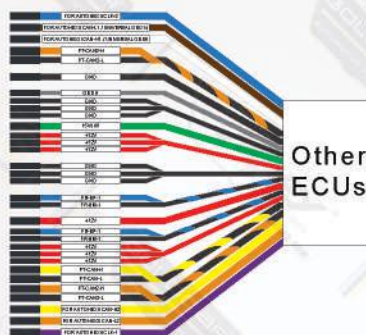
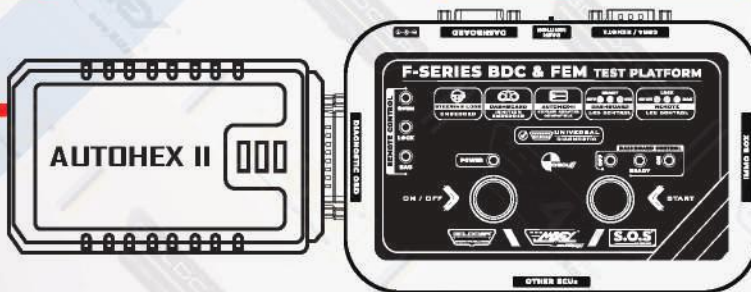

Other ECUs

Autohex-II On Bench Manual

MEVD1724

MEVD1724, MEVD1725, MEVD1728, MEVD1729, MEVD172H, MEVD172P



- Autohex-II Software ON-Bench (Please connect to the +12V AUTOHEX-II Box)
- Unplug DME from the car
- Connect wires to DME based on the below connection diagram using
- Select the DME Type from AutoHex software
- Read ISN from DME

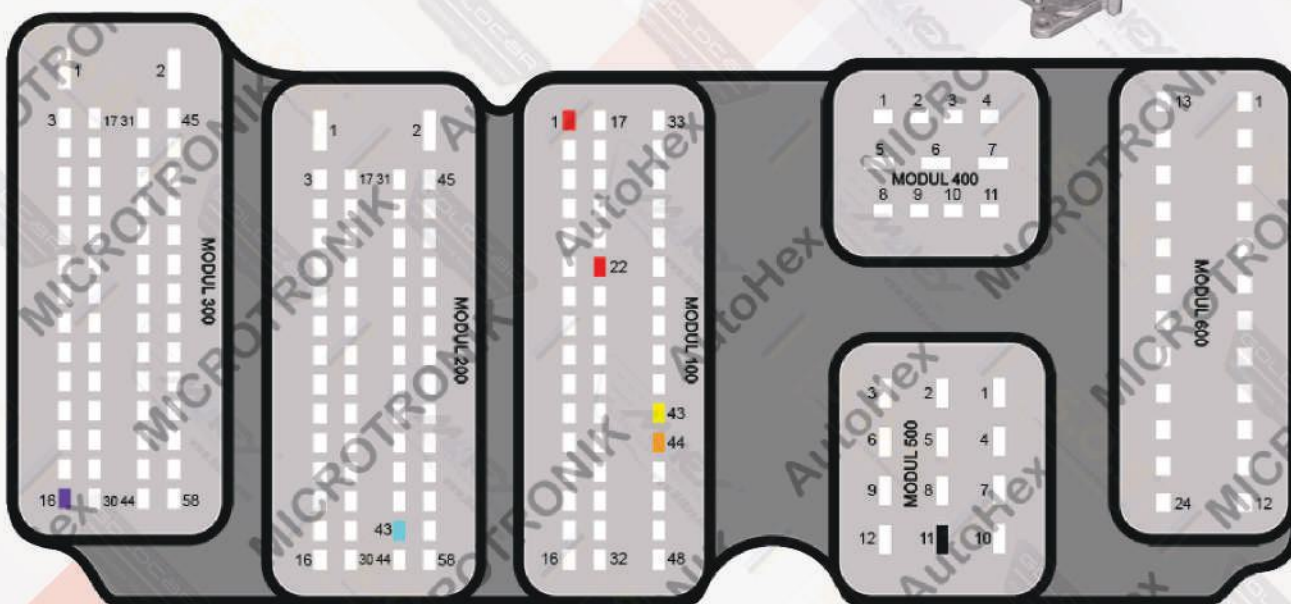

MODUL 100, 1: Out +12V
MODUL 100, 22: Out +12V

MODUL 500, 11: GND

MODUL 100, 43: AUTOHEXII CAN-H2
MODUL 100, 44: AUTOHEXII CAN-L2

MODUL 300, 16: CLK1
MODUL 200, 43: CLK2



+12V 3A
Power

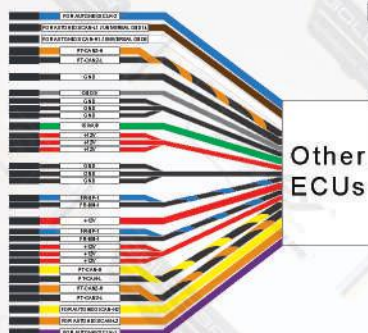
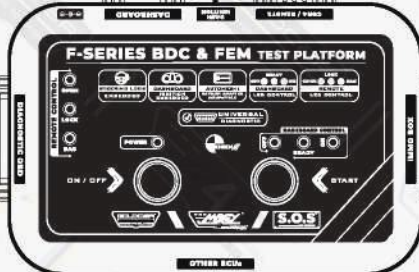

Autohex-II On Bench Manual

MEV17.2, MED17.2

MEV17.2, MED17.2

- Autohex-II Software ON-Bench (Please connect to the +12V AUTOHEX-II Box)
- Unplug DME from the car
- Connect wires to DME based on the below connection diagram using
- Select the DME Type from AutoHex software
- Read ISN from DME



SEÇENEK 2

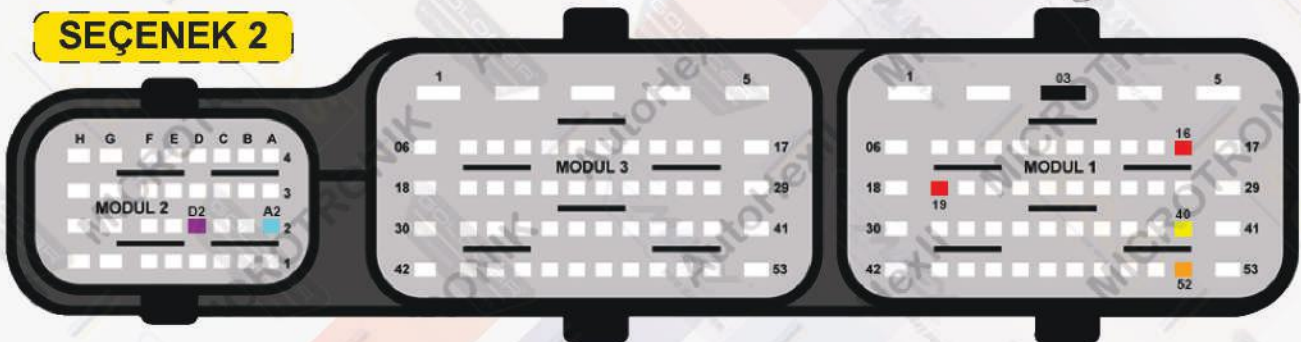

MODUL 1, 16: Out +12V
MODUL 1, 19: Out +12V

MODUL 1, 3: GND

MODUL 1, 40: AUTOHEXII
CAN-H2
MODUL 1, 52: AUTOHEXII
CAN-L2

MODUL 2, D2: CLK1
MODUL 2, A2: CLK2

SEÇENEK 1

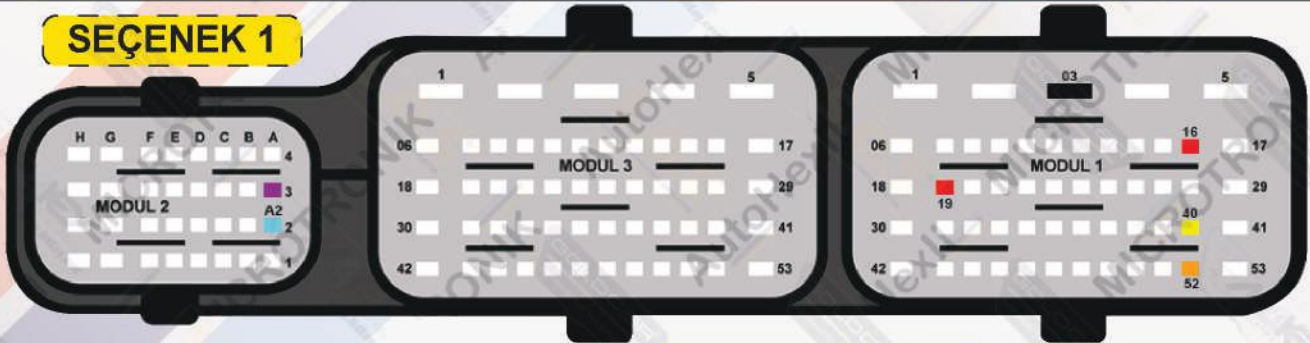

MODUL 1, 16: Out +12V
MODUL 1, 19: Out +12V

MODUL 1, 3: GND

MODUL 1, 40: AUTOHEXII
CAN-H2
MODUL 1, 52: AUTOHEXII
CAN-L2

MODUL 2, A3: CLK1
MODUL 2, A2: CLK2



+12V 3A

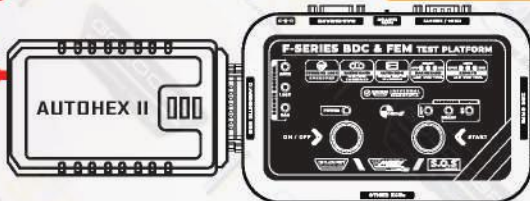

CLK1 (purple)
CLK2 (blue)
AUTOHEXII CAN-H2 (yellow)
AUTOHEXII CAN-L2 (orange)
GND (black)

OUT +12V (red)
OUT +12V (red)

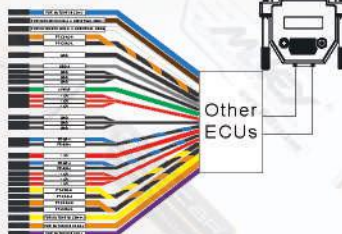

Autohex-II On Bench Manual

MEV17.4.6

MEV17.4.6



AUTOHEXII ON BENCH ISN READ

- Autohex-II Software ON-Bench (Please connect to the +12V AUTOHEX-II Box)
- Unplug DME from the car
- Connect wires to DME based on the below connection diagram using
- Select the DME Type from AutoHex software
- Read ISN from DME

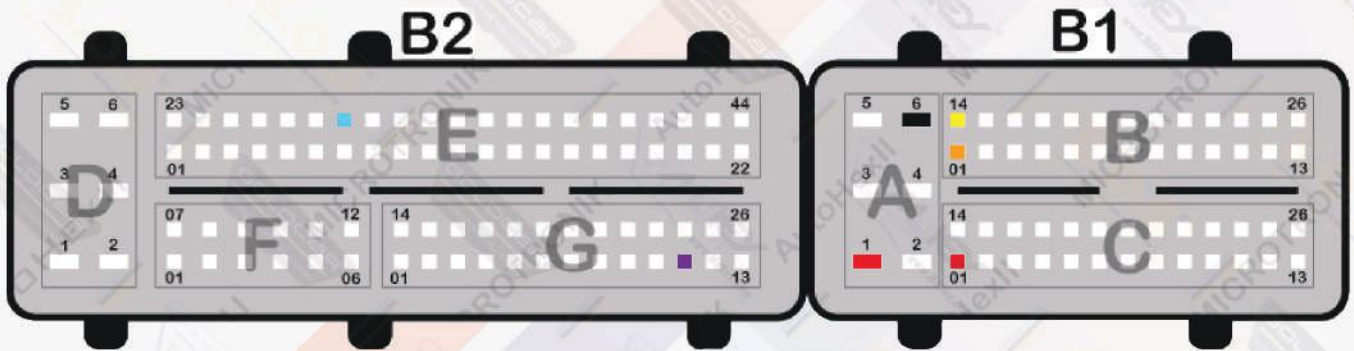

MODUL 1, A01: Out +12V
MODUL 1, C01: Out +12V

MODUL 1, A06: GND

MODUL 1, B14: AUTOHEXII CAN-H2
MODUL 1, B01: AUTOHEXII CAN-L2

MODUL 2, G11: CLK1
MODUL 2, E29: CLK2

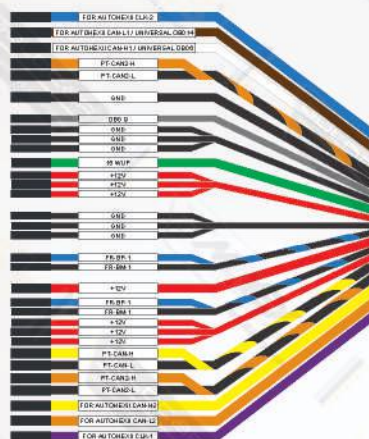
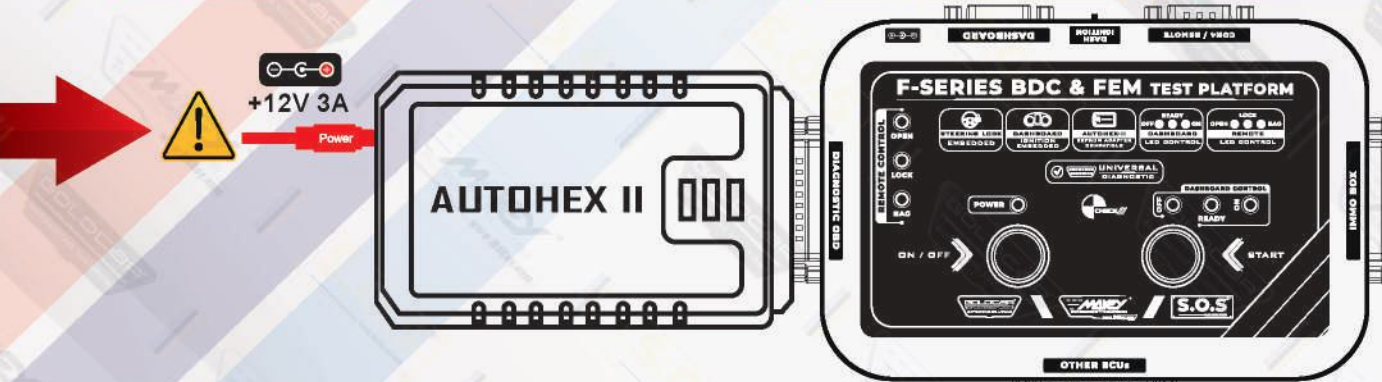

Other ECUs

Autohex-II On Bench Manual

EDC17CP02

EDC17CP02



AUTOHEXII ON BENCH ISN READ

- Autohex-II Software ON-Bench (Please connect to the +12V AUTOHEX-II Box)
- Unplug DME from the car
- Connect wires to DME based on the below connection diagram using
- Select the DME Type from AutoHex software
- Read ISN from DME

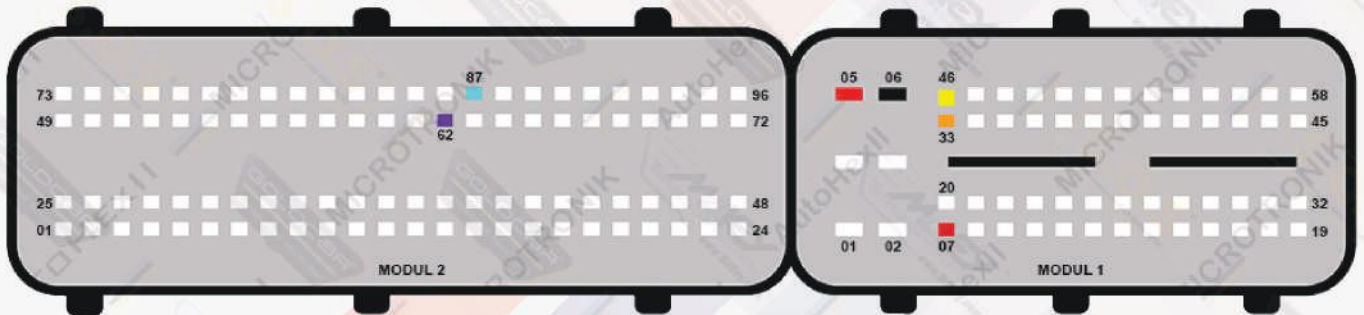

MODUL 1, 05: Out +12V
MODUL 1, 07: Out +12V

MODUL 1, 06: GND

MODUL 1, 46: AUTOHEXII CAN-H2
MODUL 1, 33: AUTOHEXII CAN-L2

MODUL 2, 62: CLK1
MODUL 2, 87: CLK2

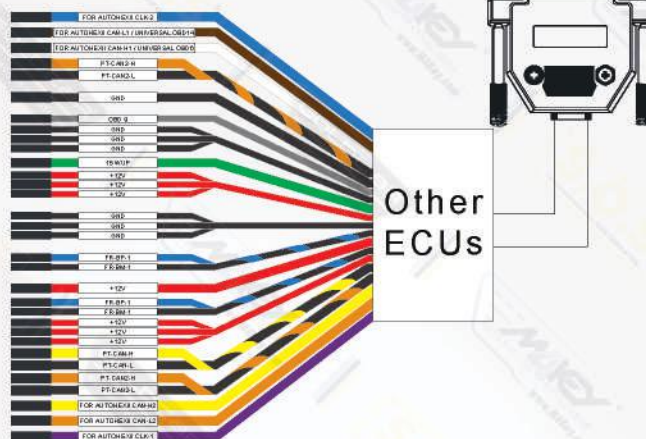
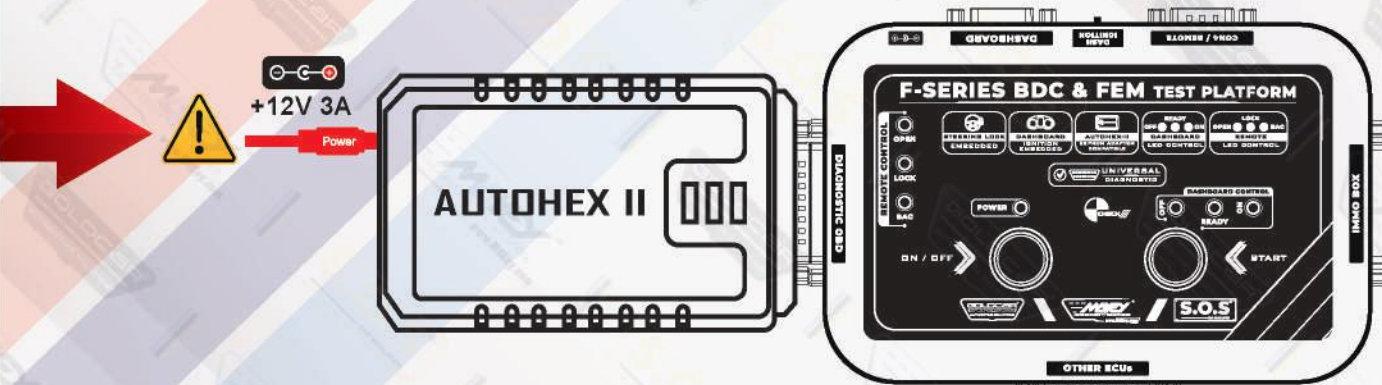

Autohex-II On Bench Manual

EDC17Cp49

EDC17Cp49, EDC17C50, EDC17C56, EDC17C76



AUTOHEXII ON BENCH ISN READ

- Autohex-II Software ON-Bench (Please connect to the +12V AUTOHEX-II Box)
- Unplug DME from the car
- Connect wires to DME based on the below connection diagram using
- Select the DME Type from AutoHex software
- Read ISN from DME

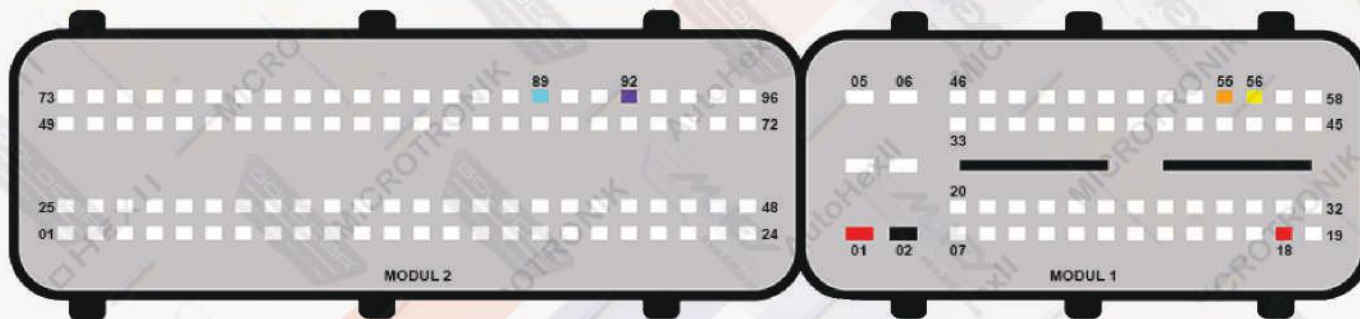

MODUL 1, 01: Out +12V
MODUL 1, 18: Out +12V

MODUL 1, 02: GND

MODUL 1, 58: AUTOHEXII CAN-H2
MODUL 1, 55: AUTOHEXII CAN-L2

MODUL 2, 92: CLK1
MODUL 2, 89: CLK2



+12V 3A
Power

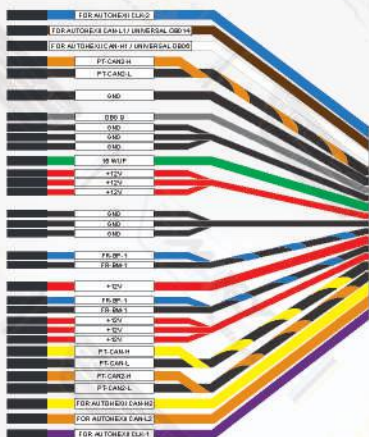
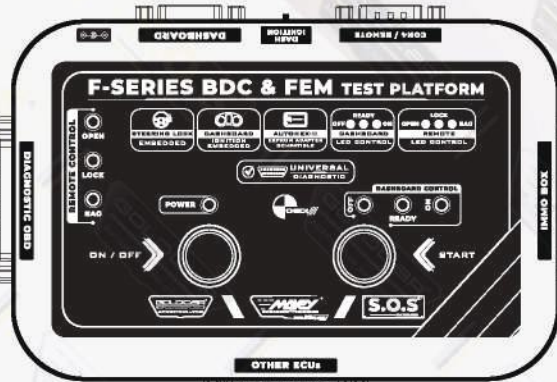

Autohex-II On Bench Manual

MEVD1723



- Autohex-II Software ON-Bench (Please connect to the +12V AUTOHEX-II Box)
- Unplug DME from the car
- Connect wires to DME based on the below connection diagram using
- Select the DME Type from AutoHex software
- Read ISN from DME

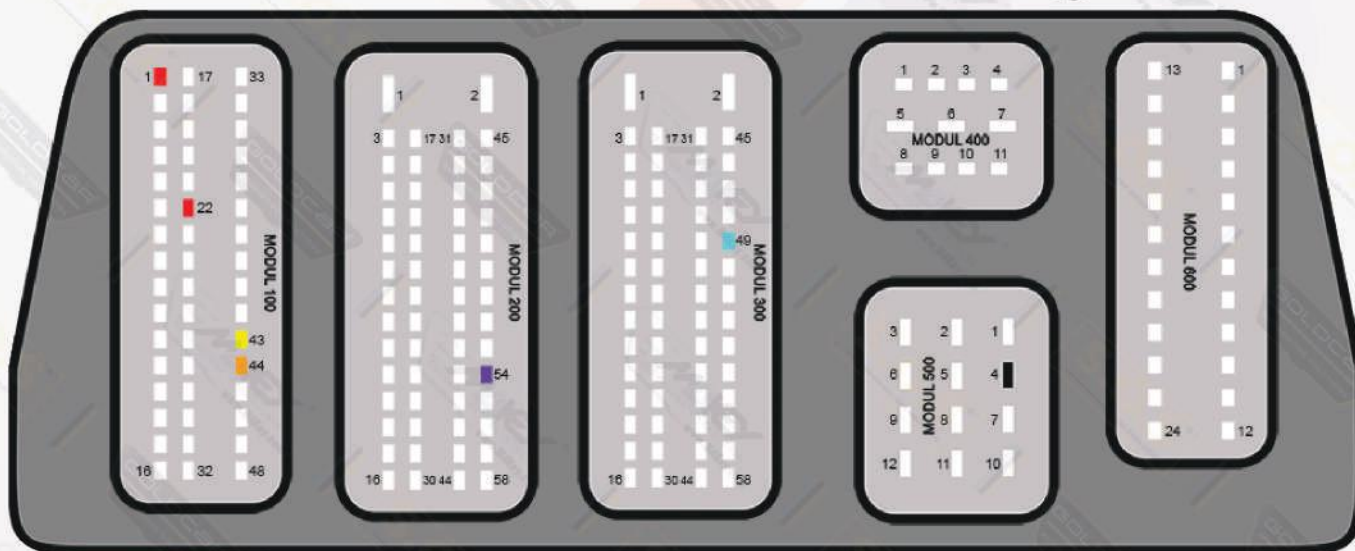

MODUL 100, 1: Out +12V
MODUL 100, 22: Out +12V

MODUL 500, 4: GND

MODUL 100, 43: AUTOHEXII CAN-H2
MODUL 100, 44: AUTOHEXII CAN-L2

MODUL 200, 54: CLK1
MODUL 300, 49: CLK2



+12V 3A
Power

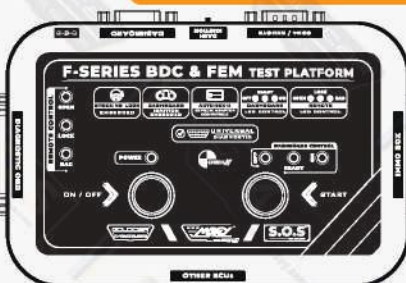

- CLK1
- CLK2
- AUTOHEXII CAN-H2
- AUTOHEXII CAN-L2
- GND
- OUT +12V
- OUT +12V

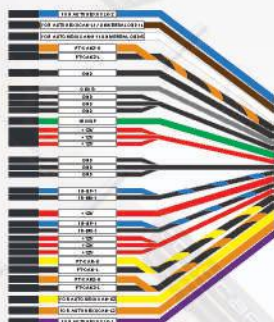

Other ECUs

Autohex-II On Bench Manual

On Bench MSD80 ISN



- Autohex-II Software ON-Bench (Please connect to the +12V AUTOHEX-II Box)
- Use below wiring to connect HW4 to the DME.
- Autohex-II Software On-Bench MSD8X ISN

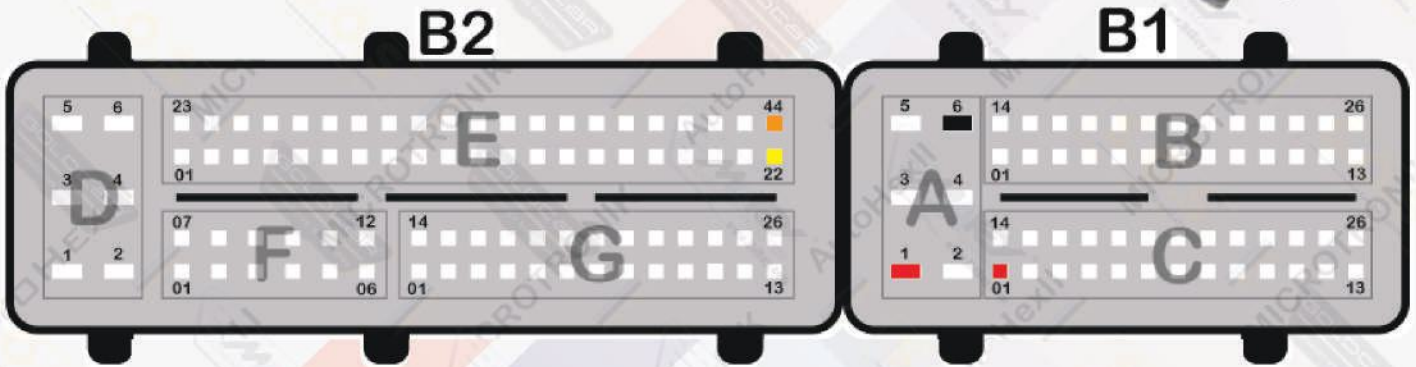

MODUL 1, C01: Out +12V
MODUL 1, A01: Out +12V

MODUL 1, A6: GND

MODUL 2, E22: AUTOHEXII CAN-H2
MODUL 2, E44: AUTOHEXII CAN-L2

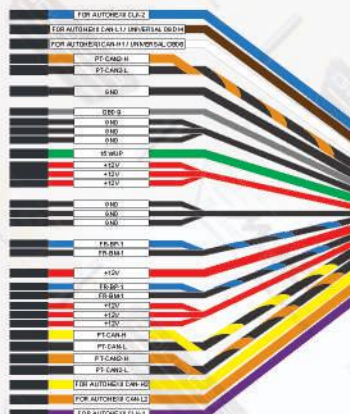
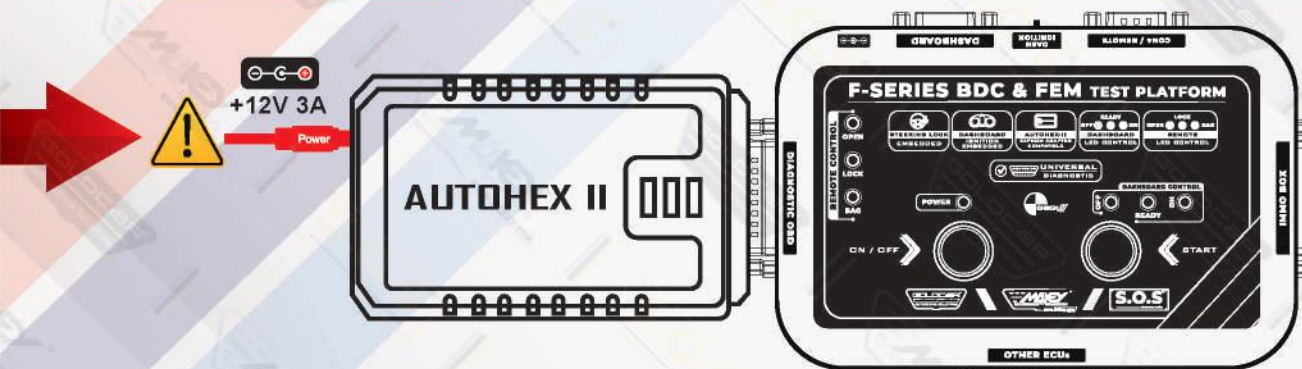

Other ECUs

Autohex-II On Bench Manual

On Bench MSD90 ISN

- Autohex-II Software ON-Bench (Please connect to the +12V AUTOHEX-II Box)
- Use below wiring to connect HW4 to the DME.
- Autohex-II Software On-Bench MSD8X ISN

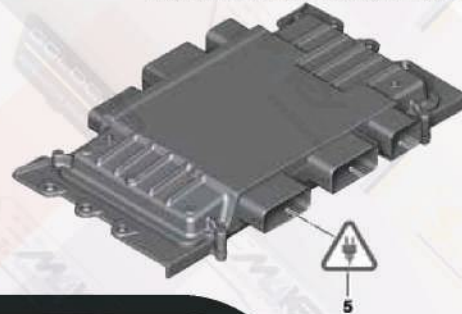

21 : Out +12V
37: Out +12V

44: GND

47: AUTOHEXII
CAN-H2
48: AUTOHEXII
CAN-L2

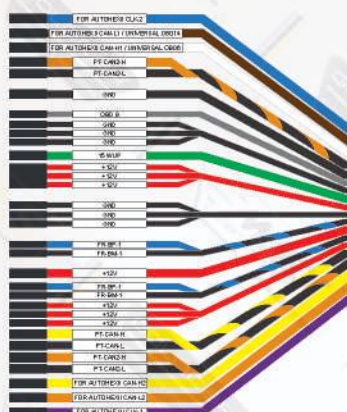
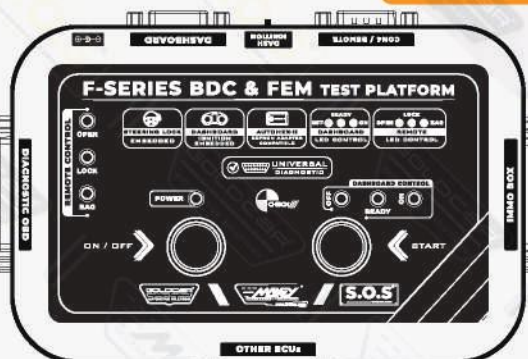

Other ECUs

Autohex-II On Bench Manual

On Bench MSD90 ISN

- Autohex-II Software ON-Bench (Please connect to the +12V AUTOHEX-II Box)
- Use bellow writing to connect HW4 to the DME.
- Autohex-II Software On-Bench MSD8X ISN

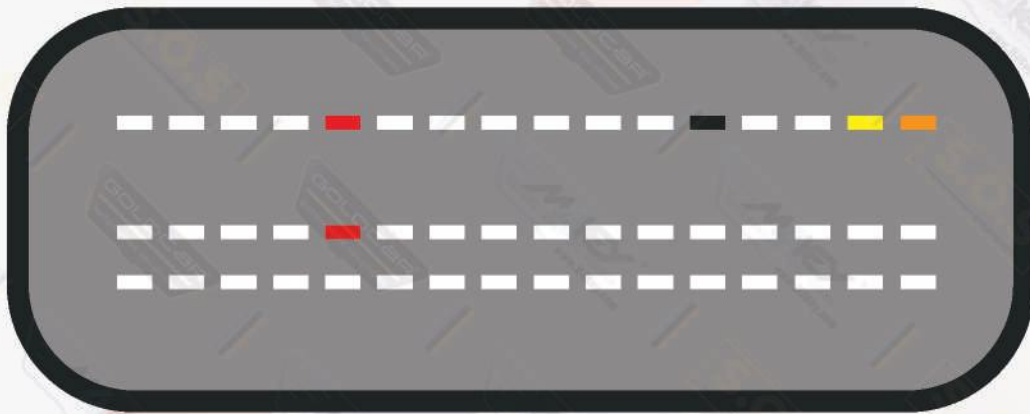

21 : Out +12V
37: Out +12V

44: GND

47: AUTOHEXII CAN-H2
48: AUTOHEXII CAN-L2

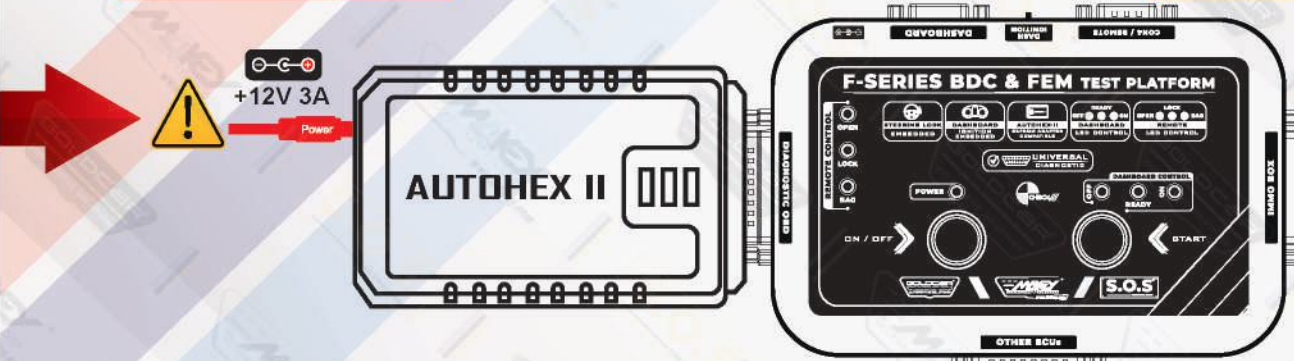

AUTOHEXII CAN-H2
AUTOHEXII CAN-L2
GND
OUT +12V
OUT +12V

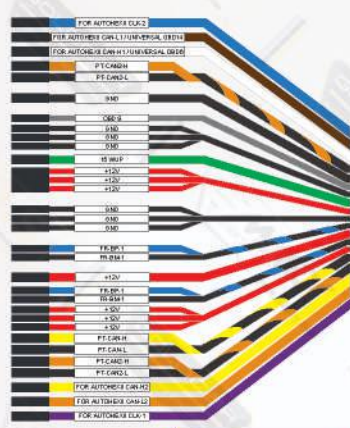

Other ECUs

Autohex-II On Bench Manual

On Bench EWS FOR 6HP



- Autohex-II Software ON-Bench (Please connect to the +12V AUTOHEX-II Box)
- Use below wiring to connect HW4 to the DME.
- Autohex-II Software On-Bench EGS EWS Reset

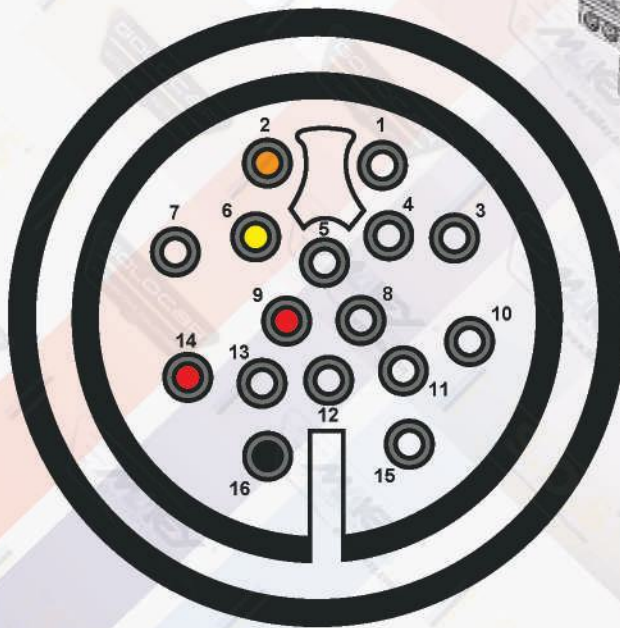
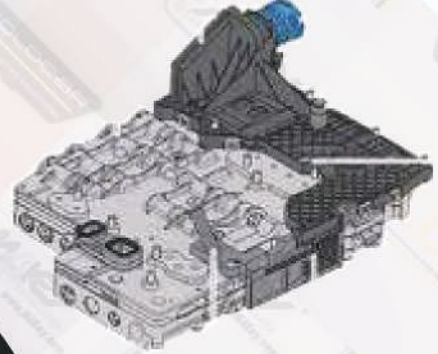

14 : Out +12V
9 : Out +12V

16 : GND

6 : AUTOHEXII
CAN-H2
2 : AUTOHEXII
CAN-L2

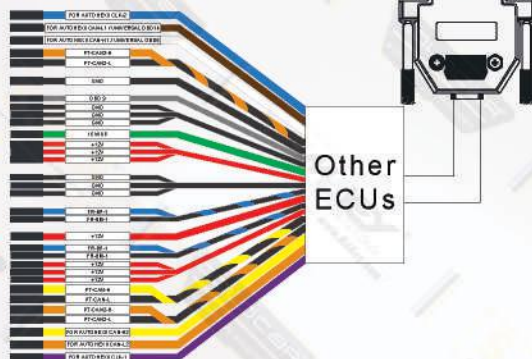
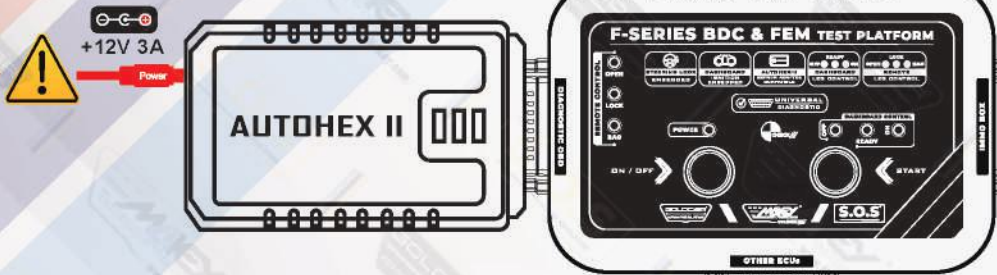

Autohex-II On Bench Manual

On Bench EWS FOR 8HP



- Autohex-II Software ON-Bench (Please connect to the +12V AUTOHEX-II Box)
- Use below wiring to connect HW4 to the DME.
- Autohex-II Software On-Bench EGS EWS Reset

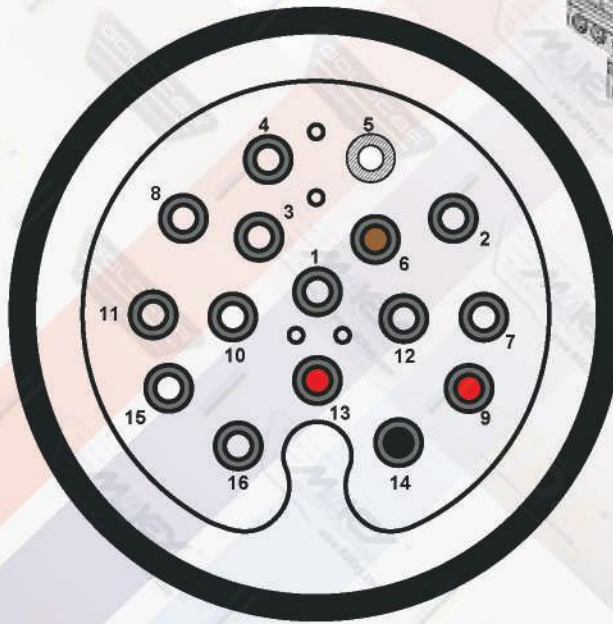
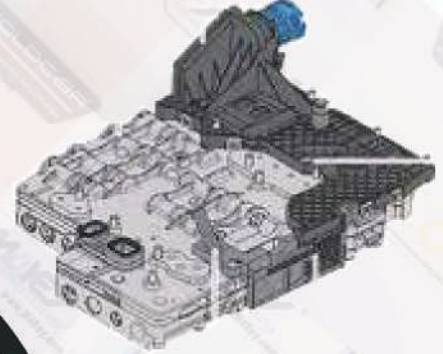

9 : Out +12V

13 : Out +12V

14 : GND

5 : AUTOHEXII CAN-H1

6 : AUTOHEXII CAN-L1

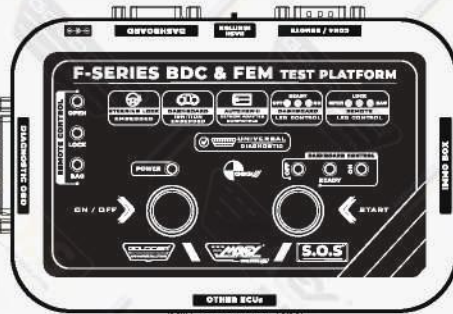

AUTOHEXII CAN-H1

AUTOHEXII CAN-L1

GND

OUT +12V

OUT +12V

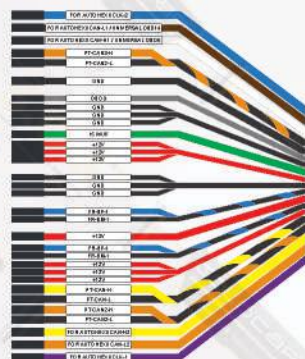

Other ECUs

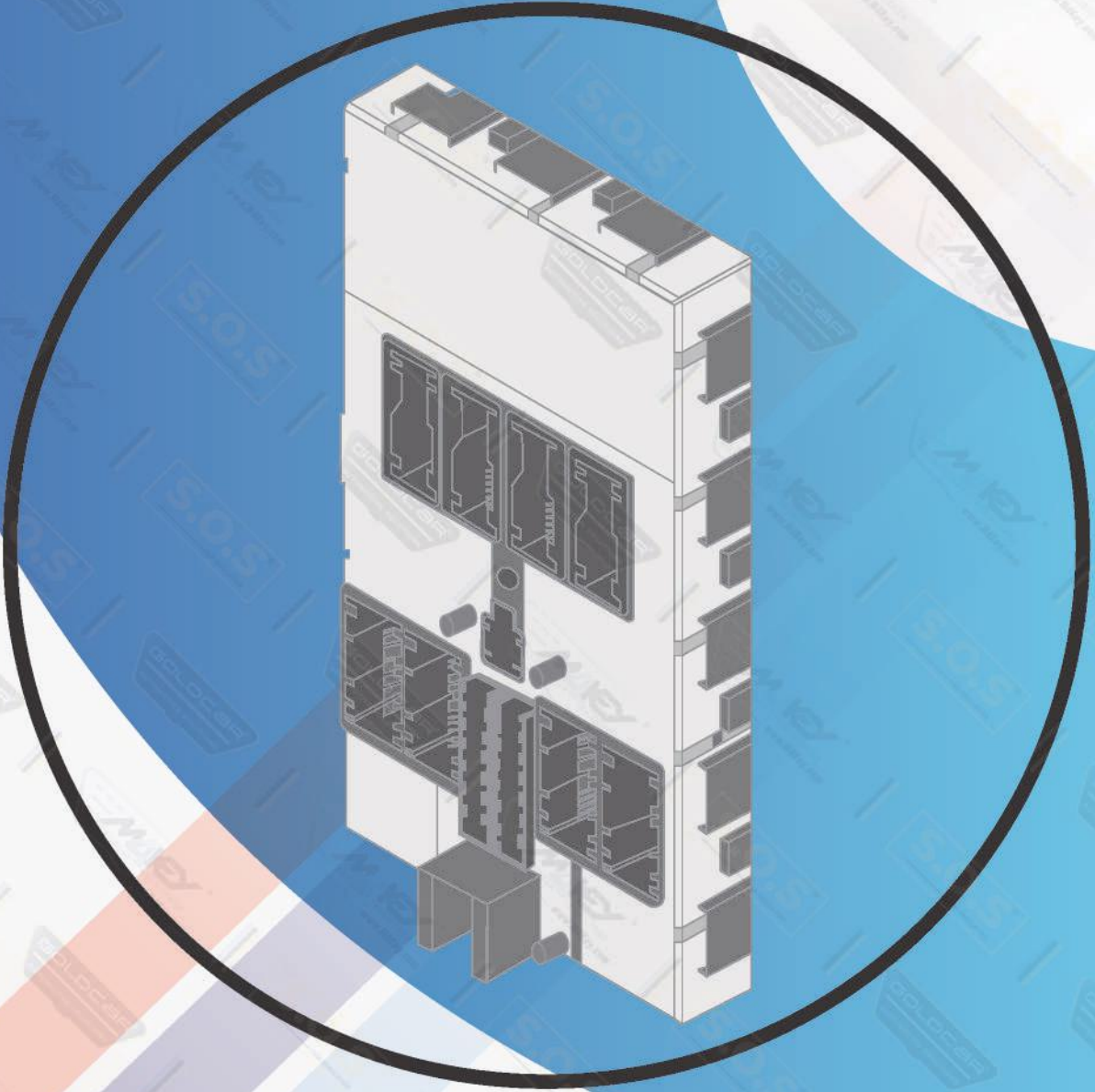

www.goldcarkeys.com

www.goldcar.com.tr

www.M4Key.com

Sanayi Mah. 60122 Nolu Cad. No: 10/A
Şehitkamil - Gaziantep / TURKEY

+90 535 813 68 20

+90 555 850 22 22